

cricket

turbo hotspot

User Guide

Support

- **On the web**

Detailed support information including device specification and troubleshooting care available at cricketwireless.com/support/devices.

- **On the phone**

Call Customer Care at 1-855-246-2461 or dial 611 from your cell phone.

Accessories

For information about accessories, visit you local Cricket store or visit cricketwireless.com/shop/accessories.

Trademarks

© 2019 Cricket Wireless LLC. All rights reserved. Cricket and the Cricket logo are registered trademarks under license to Cricket Wireless LLC.

©NETGEAR, Inc. NETGEAR and the NETGEAR Logo are trademarks of NETGEAR, Inc. Any non-NETGEAR trademarks are used for reference purposes only.

Compliance

For regulatory compliance information, visit <http://www.netgear.com/about/regulatory>. See the regulatory compliance document before connecting the power supply.

Contents

Chapter 1 Get Started

- Meet Your Mobile Hotspot.....8
 - Control Your Device Using the Power Button.....8
 - Sleep Mode.....9
 - Status LED.....9
- Set Up Your Mobile Hotspot.....9
- Recharge the Battery.....11
- Replace a SIM Card.....11
- Home Screen.....13
- Connect to the Internet.....14
- Security Credentials.....15
- NETGEAR Mobile App for Smartphones and Tablets.....15
- Connect to the Mobile Hotspot With Tethering.....16
- Customize the Mobile Hotspot Settings.....16

Chapter 2 Use Your Mobile Hotspot

- View Messages From the Mobile Hotspot.....19
- View Messages From the Mobile Hotspot Web Page.....20
- Delete a Message From the Mobile Hotspot.....20
- Delete a Message From the Mobile Hotspot Web Page.....21
- View Alerts From the Mobile Hotspot.....21
- Manage Your Broadband Network Connection.....22
 - View Mobile Broadband Network Status From the Mobile Hotspot Web Page.....22
 - Turn Domestic Data On and Off From the Mobile Hotspot Web Page.....23
- Connect to Wi-Fi.....23
 - Connect Using the Wi-Fi Password.....23
 - Add a WPS-Enabled Wi-Fi Device From the Mobile Hotspot Web Page.....24
- Manage Wi-Fi.....25
 - Turn On 2.4 GHz Wi-Fi From the Mobile Hotspot Web Page...26
 - Turn On 5 GHz Wi-Fi From the Mobile Hotspot Web Page....26
 - Turn On Dual-Band Wi-Fi From the Mobile Hotspot Web Page.....27
 - Change Wi-Fi Settings From the Mobile Hotspot Web Page...28

AirCard 797 Mobile Hotspot

Turn Guest Wi-Fi On and Off From the Mobile Hotspot Web Page.....	31
Manage Wi-Fi Security.....	33
Change Wi-Fi Network Names and Passwords From the Mobile Hotspot Web Page.....	33
Change Wi-Fi Encryption Settings.....	35

Chapter 3 Manage Security

Change the Mobile Hotspot Web Page Login Settings.....	38
Content Filter Levels.....	39
Set Up Content Filtering.....	39
Block Access to Websites.....	41
Allow Access to Websites.....	41
View, Block, or Unblock Connected Devices.....	42
View Connected Devices From the Mobile Hotspot Web Page.....	43
Block a Device From the Mobile Hotspot Web Page.....	44
Unblock a Device From the Mobile Hotspot Web Page.....	44
View a List of Blocked Devices From the Mobile Hotspot Web Page.....	45
Set Up an Internet Access Schedule.....	45
Activate SIM Security.....	47
Enable Port Forwarding.....	47
Enable Port Filtering.....	48

Chapter 4 Maintain Your Mobile Hotspot

Extend Battery Life.....	51
Adjust Wi-Fi Settings to Optimize Battery Life.....	51
Adjust Display Settings to Increase Battery Life.....	52
View Details About Your Mobile Hotspot.....	52
Back Up and Restore Mobile Hotspot Settings.....	54
Back Up Mobile Hotspot Settings Using the Web Page.....	54
Restore Mobile Hotspot Settings Using the Web Page.....	55
Restore Mobile Hotspot Settings Using the LCD Display.....	56
Configure Mobile Broadband.....	56
Enable IP Pass-Through Mode.....	56
Enable VPN Pass-Through.....	57
Configure APN Details.....	58
Add an APN for Another Network.....	58
Select an APN to Use.....	59
Remove an APN Entry.....	60
Enable DMZ.....	61
Set LAN Options.....	62
Update Mobile Hotspot Software and Firmware.....	63

Update in Response to an Alert.....64
Update Software From the Mobile Hotspot Web Page.....64

Chapter 5 Frequently Asked Questions

Questions About Connecting and Disconnecting Devices and
Accessing the Internet.....67
 What do I do if I can't connect a device to the mobile
 hotspot?.....67
 What do I do if I can't access the Internet?.....67
 How do I disconnect from the mobile broadband network?....68
 Why doesn't the Connect or Disconnect button appear on the
 mobile hotspot web page?.....68
 How do I find out how many devices are connected to my mobile
 hotspot's Wi-Fi networks?.....68
 What do I do if the No Signal icon displays?.....68
 Why can't my device access the mobile hotspot web page when
 connected to a VPN?.....69
 Why can't my mobile hotspot connect to a computer running
 Windows Vista?.....69
 What do I do if my mobile hotspot doesn't connect to my service
 provider's network?.....69
Questions About the Mobile Hotspot Web Page.....70
 How do I go back to the mobile hotspot web page?.....70
 What do I do if I forget my admin login password?.....70
General Questions.....71
 Why isn't my battery charging?.....71
 Why is the Signal Strength indicator always low?.....71
 Why is the download or upload speed slow?.....71
 The LCD screen is not lit. How do I know if the mobile hotspot is
 still powered on?.....72
 How do I find my computer's IP address?.....72
 Find the IP address on a Windows 7 , Windows Vista , or
 Windows XP device.....72
 Find the IP address on a Windows 8 device.....72
 Find the IP address on a Mac OS X device.....72
 Find the IP address on devices running other operating
 systems.....72
 How do I find a device's MAC address?.....73
 Find the MAC address on a Windows 7, Vista , or XP
 device.....73
 Find the MAC address on a Windows 8 device or newer....73
 Find the MAC address on a Mac OS X device.....74
 What do I do if the Wi-Fi network name doesn't appear in the list
 of networks?.....74

Chapter 6 Troubleshooting

View Alerts.....76
 SIM Not Installed.....76
 SIM Error – Check SIM.....76
 SIM Locked.....76
 Temperature-Related Alerts.....77
 Connection Alerts.....77
Reset the Mobile Hotspot.....79
 Reset the Mobile Hotspot From the Mobile Hotspot.....79
 Reset the Mobile Hotspot From the Mobile Hotspot Web
 Page.....79

Appendix A Specifications

Battery Specifications.....82
Display Specifications.....83
Environmental Specifications.....84
Mechanical Specifications.....84
Mobile Band Specifications.....84
Package Contents.....85
Port Specifications.....85
Security Specifications.....85
WiFi Specifications.....86

1

Get Started

This product regularly checks for new firmware and downloads any appropriate, or you can check for and download new firmware manually. If the features or behavior of your product does not match what is described in this manual, you might need to update your firmware.

This chapter provides an overview of mobile hotspot features, and instructions for how to set up your mobile hotspot and connect to the Internet. The chapter covers the following topics:

- [Meet Your Mobile Hotspot](#)
- [Set Up Your Mobile Hotspot](#)
- [Recharge the Battery](#)
- [Replace a SIM Card](#)
- [Home Screen](#)
- [Connect to the Internet](#)
- [Security Credentials](#)
- [NETGEAR Mobile App for Smartphones and Tablets](#)
- [Connect to the Mobile Hotspot With Tethering](#)
- [Customize the Mobile Hotspot Settings](#)

Meet Your Mobile Hotspot

Before you connect your mobile hotspot, familiarize yourself with its LCD screen, icons, buttons, and connectors.

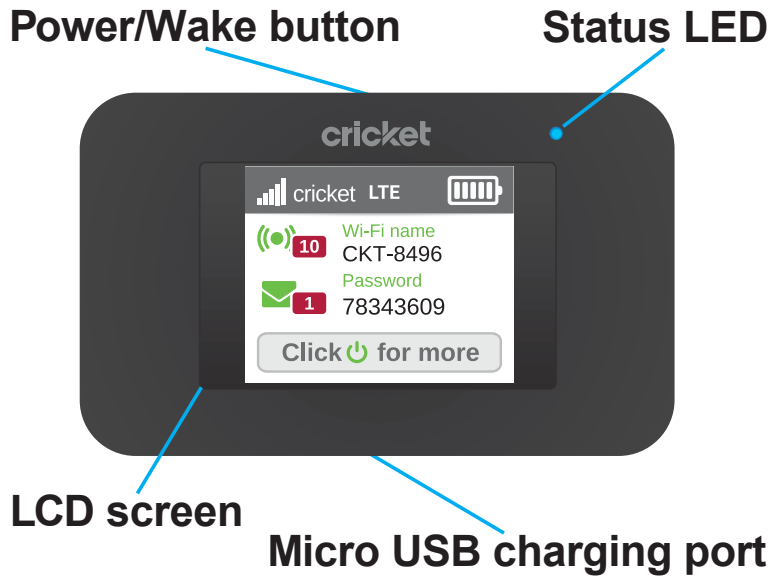

Figure 1. Mobile hotspot buttons and connectors

The mobile hotspot comes with a micro USB charging cable.

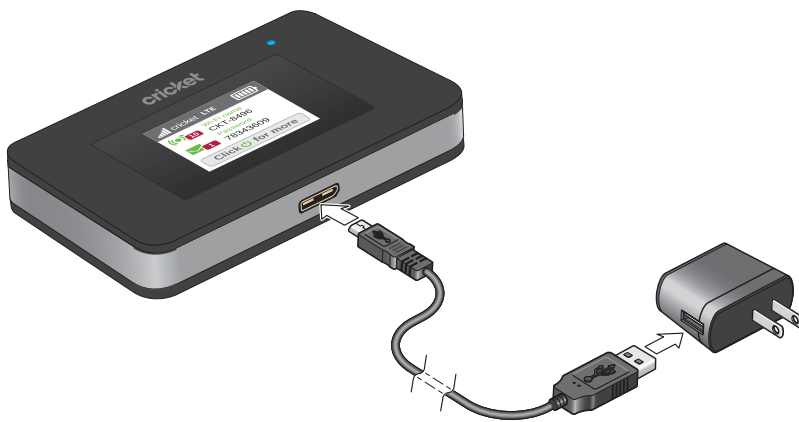

Figure 2. Mobile Hotspot Charging Cable

Control Your Device Using the Power Button

The Power button is used to turn the NETGEAR Mobile Hotspot on or off and to choose which information screen to display on the LCD.

AirCard 797 Mobile Hotspot

Turn mobile hotspot on. Press and hold Power button for 3-4 seconds

Turn mobile hotspot off. Press and hold the Power button for 3-4 seconds

Wake up WiFi signal and device screen. Press and release the Power button.

Cycle through screens. Press and release the Power button.

Sleep Mode

If there have been no transmissions or operation of your device, or if the battery has not been charged, your device automatically enters sleep mode to save power.

In sleep mode, WLAN is disabled.

Press the Power button to turn the display on and exit sleep mode.

WLAN function is enabled and WiFi devices can reconnect to the hotspot.

The time required to recover the network connection varies by environment, settings, etc.

Status LED

The status LED indicates data connection status:

- **Blue, slow blink.** The mobile hotspot is ready.
- **Blue, double-blink.** The mobile hotspot is transferring data.
- **Amber, slow blink.** The mobile hotspot is not connected to the network or is in standby mode.

Set Up Your Mobile Hotspot

The mobile hotspot comes with a SIM card in the box.

To set up your mobile hotspot:

1. Insert the SIM card.

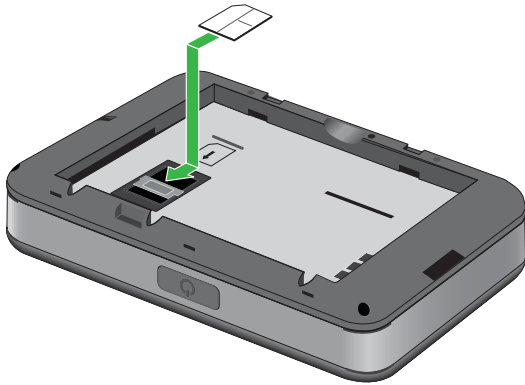

2. Insert the battery.

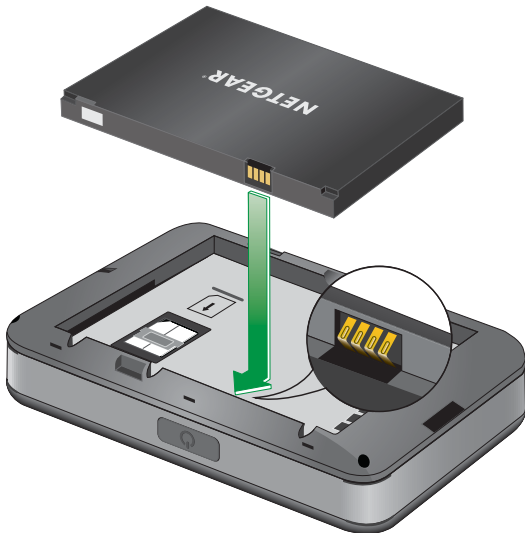

3. Install the back cover.
4. Firmly close the back cover.

5. Press the **Power** button to power on the mobile hotspot.



Recharge the Battery

Your battery comes partially charged.

To recharge your battery:

1. Connect the micro USB charging cable to your mobile hotspot.

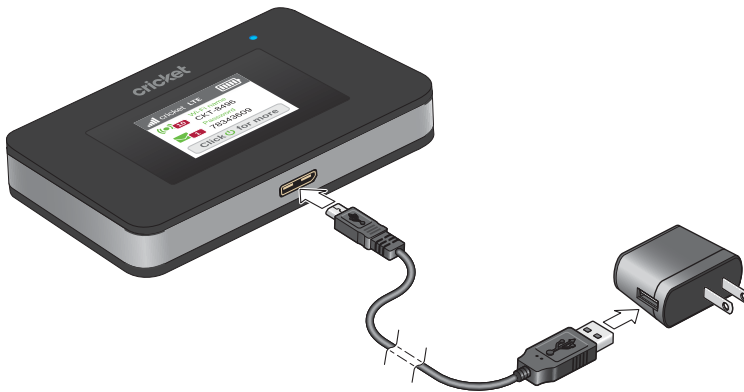

2. Connect the other end of the cable to the USB port on your computer or to the USB charger.

Replace a SIM Card

To replace a SIM card:

1. Remove the back cover by lifting the corners.
2. Remove the battery.
3. Slide out the SIM card.

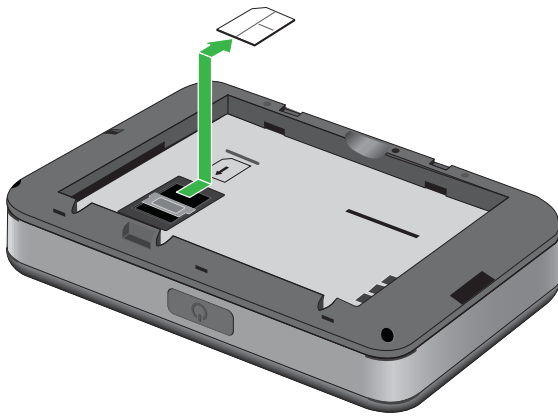

4. Insert the replacement SIM card.

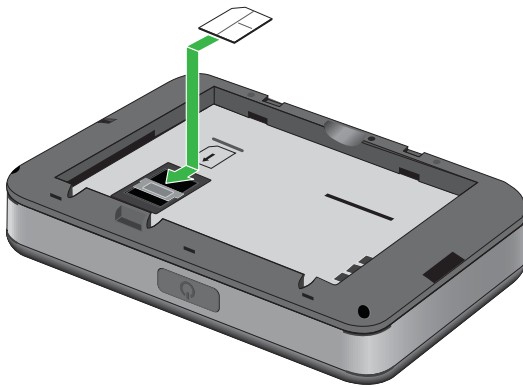

5. Insert the battery.



6. Install the back cover.

Home Screen

You can use the home screen icons to view the mobile hotspot’s status, view Wi-Fi settings, view device information, and view system alerts.

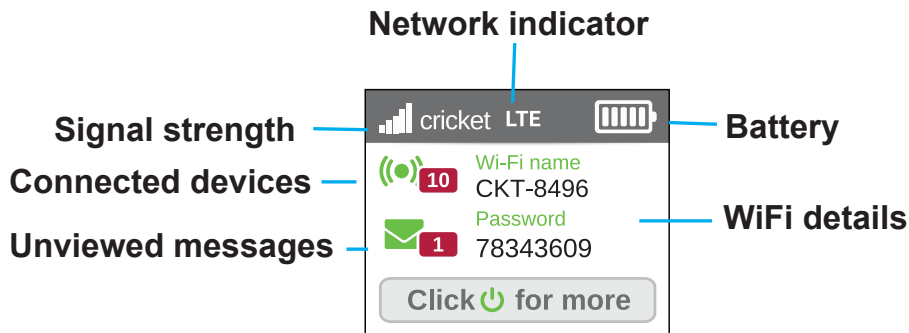

Figure 3. LCD screen display

Table 1. Icons





Icons	Description
	This indicates the strength of the mobile broadband network signal.
	This indicates your LTE wireless device is connected to one of the following networks: <ul style="list-style-type: none"> The 4G LTE network. The HSPA+ network.
	This indicates the battery is charging.
	This indicates the battery is fully charged.

Table 1. Icons (Continued)



This indicates the mobile router is plugged in to an external power supply and is operating without a battery.



This indicates there are unread alerts.

Connect to the Internet

When you turn on your mobile hotspot, it automatically connects to the network in your area. Connect your device to the mobile hotspot Wi-Fi network to access the Internet.

To connect to the Internet:

1. Press and release the **Power** button to turn on the mobile hotspot.

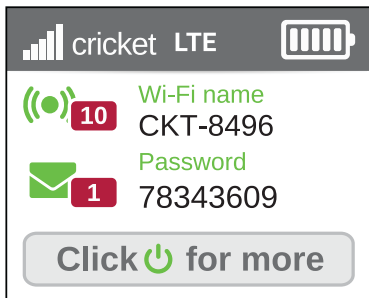

2. On your laptop or Wi-Fi device, open your Wi-Fi network connection manager.
3. Connect your device to the hotspot with the Wi-Fi name and password.

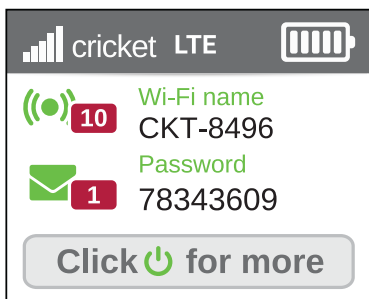

Note: Your WiFi network name is different from this example.

If guest Wi-Fi is enabled, press the power button again to reveal the guest credentials.

Security Credentials

Three passwords are associated with the mobile hotspot:

- **Wi-Fi password.** Use this to connect your computer or Wi-Fi device to your mobile hotspot network. This character string is unique to your device. It displays on the main mobile hotspot touch screen. If the screen is blank (a power-saving feature), press and quickly release the Power button. The default Wi-Fi password is also printed on a label under the battery.
For information about changing Wi-Fi passwords, see [Change Wi-Fi Encryption Settings](#) on page 35.
- **Guest Wi-Fi password.** When the guest Wi-Fi network is enabled, guests can use this password to access the network.
- **Admin login password.** Use this to log in to the mobile hotspot web page as an administrator. You must log in as an administrator to use certain features and to make changes to your mobile hotspot settings. The default admin login password, **admin**, is printed on a label under the battery. The admin login password can be 5-31 characters.

NETGEAR Mobile App for Smartphones and Tablets

Download and use the complimentary NETGEAR Mobile app to view your connection, settings, and data usage from your smartphone or tablet. Search the app store for NETGEAR Mobile.



To manage all mobile hotspot settings, visit the mobile hotspot web page at <http://cricketwifi/>.

Connect to the Mobile Hotspot With Tethering

You can connect a computer to the mobile hotspot using the micro USB cable instead of connecting with Wi-Fi. This kind of cable connection is called tethering.

Note: The tethering feature is not available on the model AC797ABS-1A1NAS, but you can use your computer to access the mobile hotspot web page.

Note: The first time you use the micro USB cable to connect to the mobile hotspot your computer's operating system detects the new device.

To install drivers on computers running Windows:

1. Ensure that the mobile hotspot is powered off.
2. Connect the mobile hotspot to your computer using the USB cable.



The mobile hotspot automatically powers on.

Note: Make sure that your computer has access to Internet when you first use the tethering feature because your computer might need to access the Internet in order to download the required software driver.

After the driver is installed, you can visit the mobile hotspot web page to customize your mobile hotspot's advanced settings. This is an optional step.

Customize the Mobile Hotspot Settings

You can personalize the mobile hotspot and change its settings on the web page.

To log in to your mobile hotspot web page:

1. From a computer or Wi-Fi device that is connected to the mobile hotspot, launch a web browser.
2. Enter **http://192.168.1.1** or **http://cricketwifi/** .
The mobile hotspot web page displays.
3. Enter the administrator login password.
The default password is **cktadmin**. The password is case-sensitive.

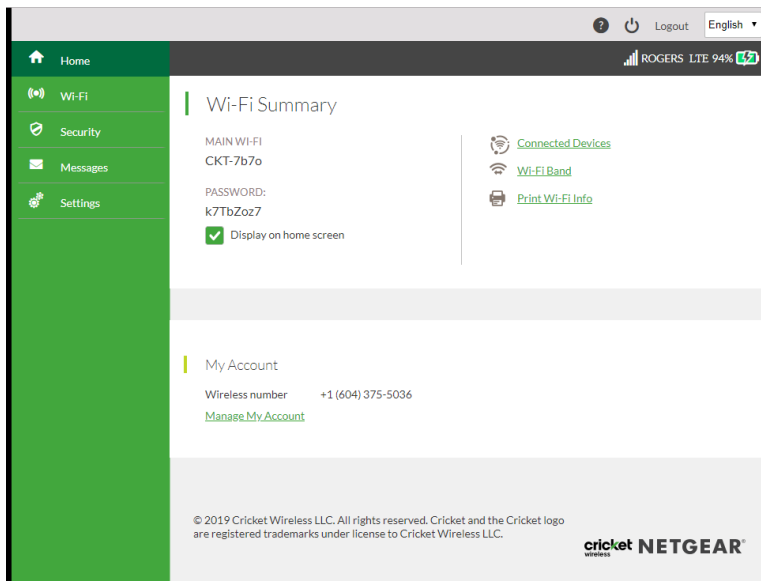

2

Use Your Mobile Hotspot

This chapter explains how to use your mobile hotspot. The chapter covers the following topics:

- [View Messages From the Mobile Hotspot](#)
- [View Messages From the Mobile Hotspot Web Page](#)
- [Delete a Message From the Mobile Hotspot](#)
- [Delete a Message From the Mobile Hotspot Web Page](#)
- [View Alerts From the Mobile Hotspot](#)
- [Manage Your Broadband Network Connection](#)
- [Connect to Wi-Fi](#)
- [Manage Wi-Fi](#)
- [Manage Wi-Fi Security](#)

View Messages From the Mobile Hotspot

You can tell from your mobile hotspot display if you have unviewed messages, and you can view them directly from there.

This hotspot display indicates you have an unread message.

Note: Although you can view messages directly on the mobile hotspot, use the mobile hotspot's web page to delete them.

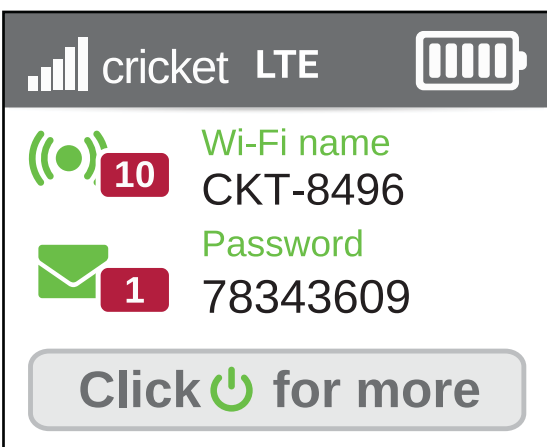

To view messages from the mobile hotspot display:

1. Press the **Power** button to wake the mobile hotspot.
2. Tap the **Messages** icon.
The **Messages** screen displays.
3. Tap the message to read the full text.

Note: If you are logged in as an administrator, the **Messages** option on the side menu indicates unread network messages. You can view SMS messages from your network service provider on the mobile hotspot web page.

View Messages From the Mobile Hotspot Web Page

To view messages from the mobile hotspot web page:

1. From a computer or Wi-Fi device that is connected to the mobile hotspot, launch a web browser.
2. Enter **http://192.168.1.1** or **http://cricketwifi/** .
The mobile hotspot web page displays.
3. Enter the administrator login password.
The default password is **cktadmin**. The password is case-sensitive.
The home page displays.
4. Select **Messages**.
A list of messages displays, showing the first portion of the text.
5. Click a message to read the full text.

Delete a Message From the Mobile Hotspot

You can delete messages from your mobile hotspot display.

To delete messages from the mobile hotspot display:

1. Tap **Power** to wake the mobile hotspot.

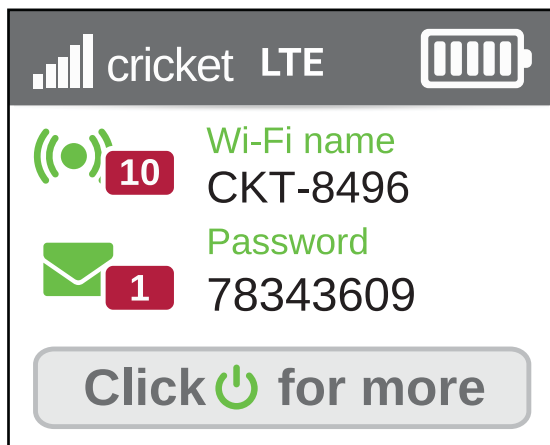

2. Tap the **Messages** icon.
The **Messages** screen displays.

3. Tap the message to select it.
4. Tap the **Delete** button.
The message is deleted.

Delete a Message From the Mobile Hotspot Web Page

To delete a message from the mobile hotspot web page:

1. From a computer or Wi-Fi device that is connected to the mobile hotspot, launch a web browser.
2. Enter `http://192.168.1.1` or `http://cricketwifi/`.
The mobile hotspot web page displays.
3. Enter the administrator login password.
The default password is `cktadmin`. The password is case-sensitive.
The home page displays.
4. Select **Messages**.
A list of messages displays, showing the first portion of the text.
5. Select the message and click the **Delete** button.
The message is deleted.

View Alerts From the Mobile Hotspot

Your mobile hotspot displays alerts to advise you of device status changes. When there are outstanding alerts, the alerts displays on the screen. Alerts remain as long as the issues that cause them are active. When the issues are resolved, the alerts are removed automatically.

To view alerts from the mobile hotspot web page:

1. From a computer or Wi-Fi device that is connected to the mobile hotspot, launch a web browser.
2. Enter `http://192.168.1.1` or `http://cricketwifi/`.
The mobile hotspot web page displays.
3. Enter the administrator login password.

The default password is **cktadmin**. The password is case-sensitive.

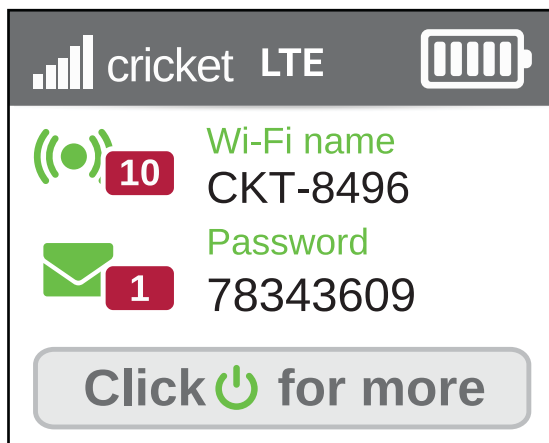

Follow the instructions in each alert to address the conditions that caused it to display.

Manage Your Broadband Network Connection

You can view the mobile broadband network status and turn domestic data on and off.

View Mobile Broadband Network Status From the Mobile Hotspot Web Page

To view network status from the mobile hotspot web page:

1. From a computer or Wi-Fi device that is connected to the mobile hotspot, launch a web browser.
2. Enter **http://192.168.1.1** or **http://cricketwifi/** .
The mobile hotspot web page displays.
3. Enter the administrator login password.
The default password is **cktadmin**. The password is case-sensitive.
The home page displays.
4. Select **Settings > About**.
The About page displays.
5. View the Network Status section.

Turn Domestic Data On and Off From the Mobile Hotspot Web Page

To turn domestic data on and off from the mobile hotspot:

1. From a computer or Wi-Fi device that is connected to the mobile hotspot, launch a web browser.
2. Enter **http://cricketwifi/**.
The mobile hotspot web page displays.
3. Enter the administrator login password.
The default password is admin. The password is case-sensitive.
The home page displays.
4. Select **Settings > Mobile Broadband > Preferences**.
The preferences page displays.
5. Click the **Domestic Data** button.
The Save and Cancel buttons display at the bottom of the page.
6. Click the **Save** button.
Your settings are saved.

Connect to Wi-Fi

You can connect up to 15 Wi-Fi devices (such as smartphones, laptops, tablets, digital cameras, printers, gaming consoles, and digital picture frames) to your mobile hotspot network. For information about setting connections for main Wi-Fi and guest Wi-Fi networks, see [View Mobile Broadband Network Status From the Mobile Hotspot on page ?](#).

You can add a Wi-Fi device to your Wi-Fi network manually. If the device that you are adding is WPS enabled, you can use the WPS method to connect the device without using the Wi-Fi password.

Connect Using the Wi-Fi Password

To connect using the Wi-Fi password:

1. On the Wi-Fi device, view the list of available Wi-Fi networks.
2. Connect to the network that corresponds to your mobile hotspot network as displayed on the LCD screen.

3. When prompted, enter the Wi-Fi password for your mobile hotspot network.
The Wi-Fi password displays on the mobile hotspot LCD screen. If the screen is turned off, press and quickly release the **Power** button to wake the mobile hotspot.

Add a WPS-Enabled Wi-Fi Device From the Mobile Hotspot Web Page

You can add a WPS-enabled Wi-Fi device to your Wi-Fi network without a Wi-Fi password, using the mobile hotspot or the mobile hotspot web page. Note that this feature is not available on the AC797ABS-1A1NAS model mobile hotspot.

To add a WPS-enabled Wi-Fi device from the mobile hotspot web page:

1. From a computer or Wi-Fi device that is connected to the mobile hotspot, launch a web browser.
2. Enter **http://192.168.1.1** or **http://cricketwifi/**.
The mobile hotspot web page displays.
3. Enter the administrator login password.
The default password is cktadmin. The password is case-sensitive.
The home page displays.
4. Select **Wi-Fi > Connect**.

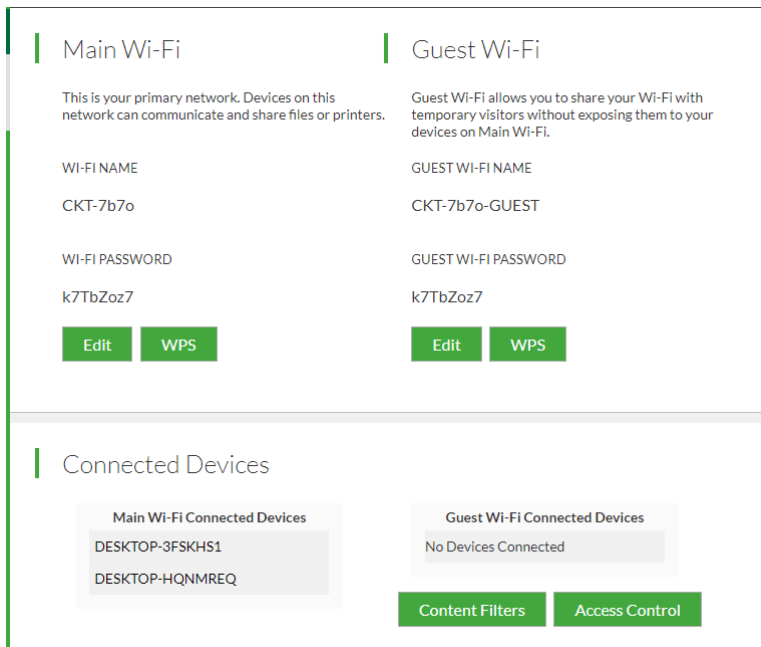

5. Click the **WPS** button for either the main Wi-Fi or guest Wi-Fi network (if available).

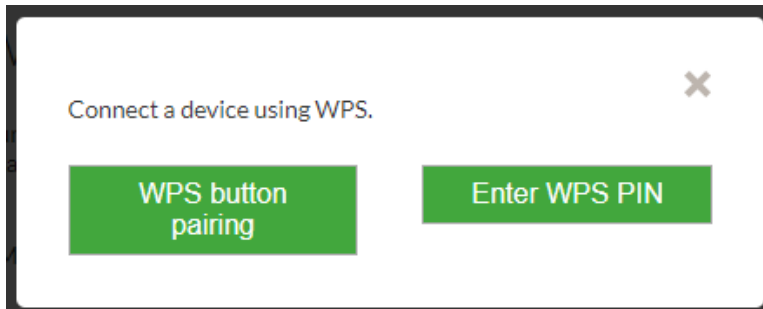

6. Click the button for the WPS method that you want to use:
 - **WPS button pairing.** If the device that you want to connect includes a WPS key, click the **WPS button pairing** button and, within two minutes (120 seconds), press the device's WPS key.
 - **Enter WPS PIN.** If a WPS pin is associated with the device that you want to connect, click the **Enter WPS PIN** button and enter the device's WPS PIN.

Your mobile hotspot and the Wi-Fi device communicate and establish the connection.

Manage Wi-Fi

Advanced users can set up the Wi-Fi radio of the mobile hotspot to meet their Wi-Fi needs by customizing settings on the mobile hotspot web page.

On the mobile hotspot web page, the following Wi-Fi profiles are available:

- **Dual-band Wi-Fi (2.4 GHz and 5 GHz).** Connect 2.4 GHz and 5 GHz devices to transfer data at higher throughputs.
- **2.4 GHz Wi-Fi.** Use only the 2.4 GHz Wi-Fi band.
- **5 GHz Wi-Fi.** Use only the 2.4 GHz Wi-Fi band.
- **Turn off Wi-Fi.** Turn off the Wi-Fi signal from the mobile router. With this setting, you can only connect to the mobile router with a tethered USB connection.

By default, Wi-Fi is enabled and guest Wi-Fi are disabled. If your place of business does not allow Wi-Fi or for any other reason you want to disable Wi-Fi and use the mobile hotspot only in tethered mode, the mobile hotspot gives you that option.

Note: Whenever you change Wi-Fi settings, any devices connected to the mobile hotspot are disconnected and might need to be reconnected.

Turn On 2.4 GHz Wi-Fi From the Mobile Hotspot Web Page

To turn on 2.4 GHz Wi-Fi from the mobile hotspot web page:

1. From a computer or Wi-Fi device that is connected to the mobile hotspot, launch a web browser.
2. Enter **http://192.168.1.1** or **http://cricketwifi/** .
The mobile hotspot web page displays.
3. Enter the administrator login password.
The default password is cktadmin. The password is case-sensitive.
The home page displays.
4. Select **Wi-Fi > Options**.

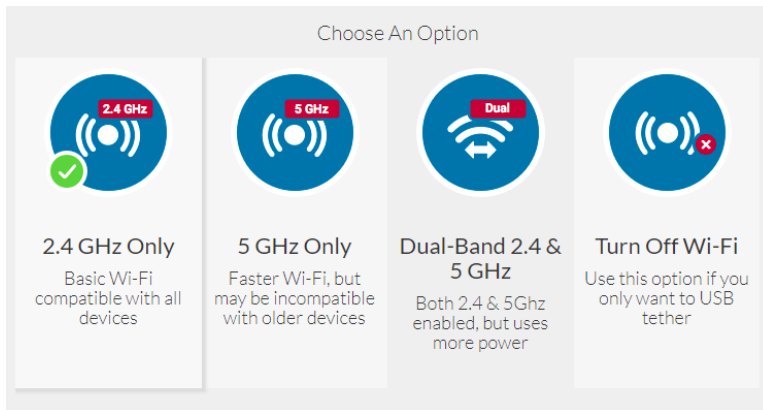

5. Select **2.4 GHz Only**.
The Save and Cancel buttons display at the bottom of the page.
6. Click the **Save** button.
A message displays telling you that to save this change, your device must restart Wi-Fi connections.
7. Click the **Save** button.
Your settings are saved.

Turn On 5 GHz Wi-Fi From the Mobile Hotspot Web Page

When all of your devices support 5 GHz Wi-Fi, use 5 GHz Wi-Fi for faster downloads.

To turn on 5 GHz Wi-Fi from the mobile hotspot web page:

1. From a computer or Wi-Fi device that is connected to the mobile hotspot, launch a web browser.
2. Enter **http://192.168.1.1** or **http://cricketwifi/** .
The mobile hotspot web page displays.
3. Enter the administrator login password.
The default password is cktadmin. The password is case-sensitive.
The home page displays.
4. Select **Wi-Fi > Options**.

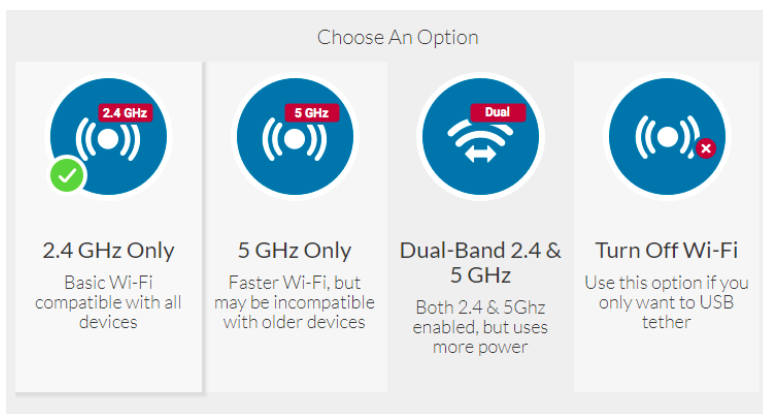

5. Select **5GHz Only**.
The Save and Cancel buttons display at the bottom of the page.
6. Click the **Save** button.
A message displays telling you that to save this change, your device must restart Wi-Fi connections.
7. Click the **Save** button.
Your settings are saved.

Turn On Dual-Band Wi-Fi From the Mobile Hotspot Web Page

The mobile hotspot can broadcast Wi-Fi signals in the 2.4 GHz and 5 GHz Wi-Fi bands. Note that the overall throughput speed could decrease when Wi-Fi dual-band is enabled.

To turn on dual-band Wi-Fi from the mobile hotspot web page:

1. From a computer or Wi-Fi device that is connected to the mobile hotspot, launch a web browser.
2. Enter **http://192.168.1.1** or **http://cricketwifi/**.
The mobile hotspot web page displays.
3. Enter the administrator login password.
The default password is cktadmin. The password is case-sensitive.
The home page displays.
4. Select **Wi-Fi > Options**.

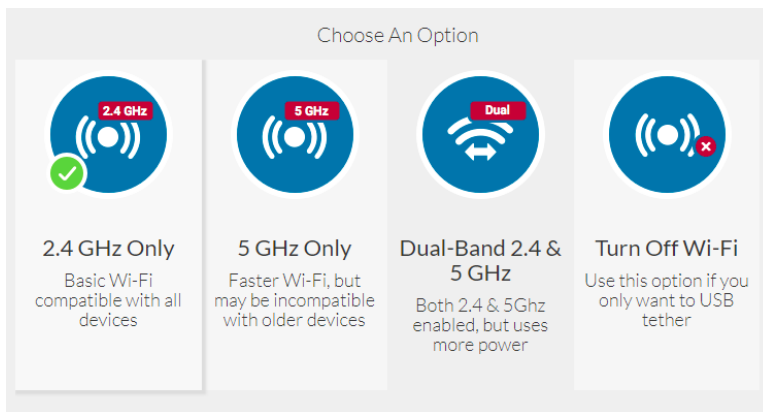

5. Select **Dual-Band 2.4 & 5 GHz**.
The Save and Cancel buttons display at the bottom of the page.
6. Click the **Save** button.
A message displays telling you that to save this change, your device must restart Wi-Fi connections.
7. Click the **Save** button.
Your settings are saved.

Change Wi-Fi Settings From the Mobile Hotspot Web Page

To select a Wi-Fi profile or create a custom profile on the mobile hotspot web page:

1. From a computer or Wi-Fi device that is connected to the mobile hotspot, launch a web browser.
2. Enter **http://192.168.1.1** or **http://cricketwifi/**.
The mobile hotspot web page displays.

AirCard 797 Mobile Hotspot

3. Enter the administrator login password.
The default password is **cktadmin**. The password is case-sensitive.
The home page displays.
4. Select **Wi-Fi > Options**.

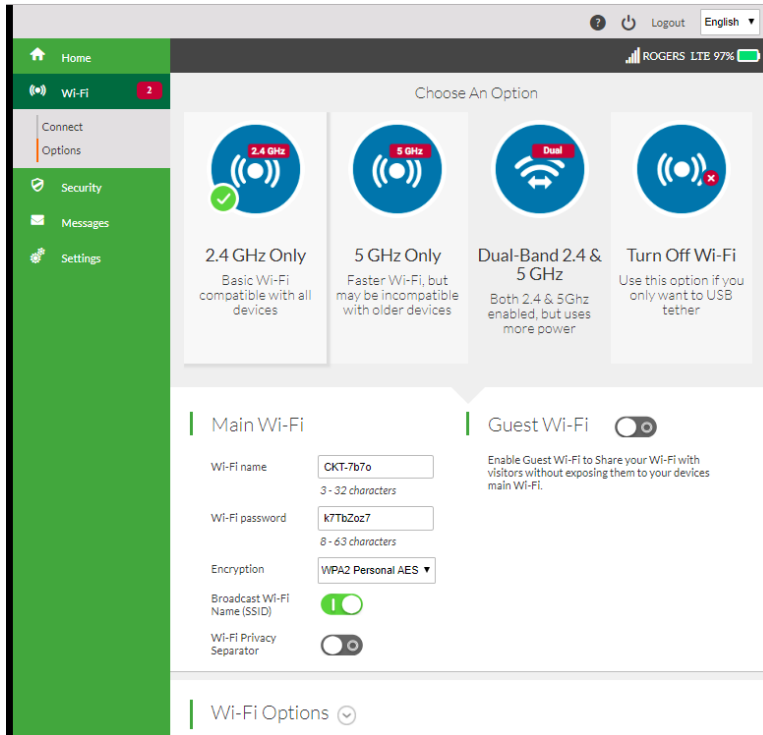

- Click the down arrow next to Wi-Fi options.

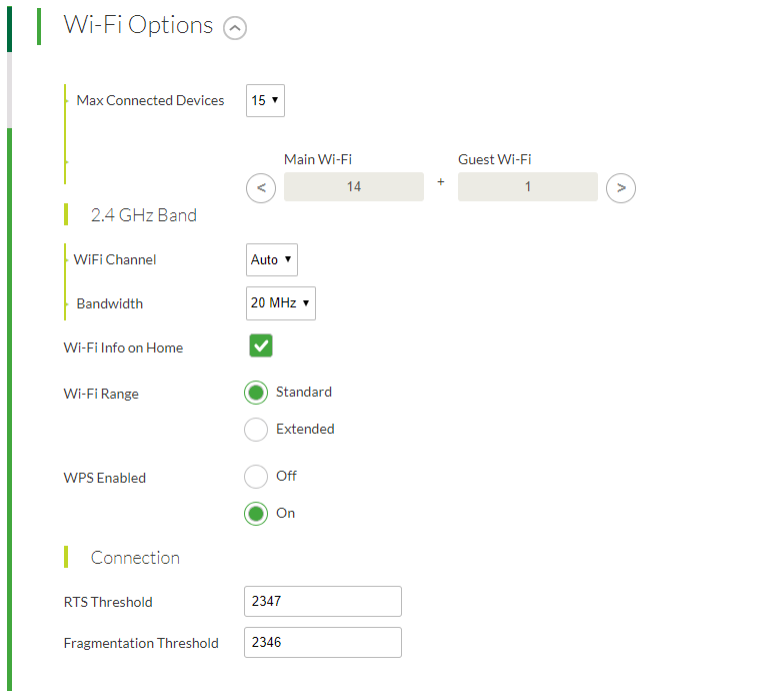

- To change the maximum number of devices that can connect to the Wi-Fi network:
 - In the **Max Connected Devices** menu, select a number.
 - Click the arrow buttons to change the numbers in the **Main Wi-Fi** and **Guest Wi-Fi** fields.
- Set the Wi-Fi channel.

Best practice is to set the channel to **Auto**. The mobile hotspot chooses the channel that provides the least interference.
- Set the Wi-Fi channel.

Best practice is to set the channel to **Auto**. The mobile hotspot chooses the channel that provides the least interference.
- Set the Wi-Fi bandwidth.

You can set this to 20 MHz or 40 MHz for 2.4 GHz or 40 MHz or 80 MHz for 5 GHz.
- To allow the Wi-Fi information to be displayed on the mobile hotspot home screen, leave the Wi-Fi Info on Home check box selected.
- Set the Wi-Fi range.

Selecting the Extended radio button expands the range of the mobile hotspot. This setting uses more battery power than the Standard setting.

12. Specify advanced connection settings:

- **RTS Threshold.** The smallest packet size (in bytes) used by the Request to Send/Clear to Send handshaking protocol. Best practice is to use a value of 2347. If you are experiencing inconsistent data flow, you can make minor changes to this value to try to alleviate the problem.
- **Fragmentation Threshold.** The largest allowable size (in bytes) for a packet. If a packet is larger than the threshold, it is sent in multiple packets, which can affect network performance. Keep this value as large as possible (up to 2346).

13. Click the **Save** button.

A message displays to tell you that changing the Wi-Fi info will temporarily cause connectivity loss.

14. Click the **OK** button.

Your settings are saved.

Turn Guest Wi-Fi On and Off From the Mobile Hotspot Web Page

Guest Wi-Fi lets temporary visitors access your Wi-Fi mobile hotspot without having to share your main Wi-Fi password. Guest Wi-Fi uses the same band (2.4 GHz or 5 GHz) as your main Wi-Fi.

To enable guest Wi-Fi from the mobile hotspot web page:

1. From a computer or Wi-Fi device that is connected to the mobile hotspot, launch a web browser.
2. Enter **http://192.168.1.1** or **http://cricketwifi/**.
The mobile hotspot web page displays.
3. Enter the administrator login password.
The default password is **cktadmin**. The password is case-sensitive.
The home page displays.

4. Select **Wi-Fi > Connect**.

The screenshot shows the 'Connect' page with two columns: 'Main Wi-Fi' and 'Guest Wi-Fi'. Below these is a 'Connected Devices' section.

Main Wi-Fi	Guest Wi-Fi
<p>This is your primary network. Devices on this network can communicate and share files or printers.</p> <p>WI-FI NAME CKT-7b7o</p> <p>WI-FI PASSWORD k7TbZoz7</p> <p>Edit WPS</p>	<p>Guest Wi-Fi allows you to share your Wi-Fi with temporary visitors without exposing them to your devices on Main Wi-Fi.</p> <p>GUEST WI-FI NAME CKT-7b7o-GUEST</p> <p>GUEST WI-FI PASSWORD k7TbZoz7</p> <p>Edit WPS</p>

Main Wi-Fi Connected Devices	Guest Wi-Fi Connected Devices
<p>DESKTOP-3FSKH51</p> <p>DESKTOP-HQNMREQ</p>	<p>No Devices Connected</p>

Content Filters **Access Control**

5. Click the **Guest Wi-Fi Edit** button.

The screenshot shows the 'Edit' page for Guest Wi-Fi. The 'Guest Wi-Fi' toggle is turned on.

Main Wi-Fi	Guest Wi-Fi
<p>Wi-Fi name: CKT-7b7o (3 - 32 characters)</p> <p>Wi-Fi password: k7TbZoz7 (8 - 63 characters)</p> <p>Encryption: WPA2 Personal AES</p> <p>Broadcast Wi-Fi Name (SSID): <input checked="" type="checkbox"/></p> <p>Wi-Fi Privacy Separator: <input type="checkbox"/></p>	<p>Guest Wi-Fi <input checked="" type="checkbox"/></p> <p>Wi-Fi name: CKT-7b7o-GUEST (3 - 32 characters)</p> <p>Wi-Fi password: k7TbZoz7 (8 - 63 characters)</p> <p>Generate Passphrase: <input checked="" type="checkbox"/></p> <p>Encryption: WPA2 Personal AES</p> <p>Broadcast Network Name: <input checked="" type="checkbox"/></p> <p>Guest Timer: 4 hours</p>

6. Click the **Guest Wi-Fi** button.

The Save and Cancel buttons display at the bottom of the page.

7. To set a timer for the guest network, select the length of time in the **Guest Timer** menu.

8. Click the **Save** button.

A message displays telling you that to save this change, your device must restart Wi-Fi connections.

9. Click the **Save** button.

Your settings are saved.

Manage Wi-Fi Security

Note: When you change the Wi-Fi settings, the mobile hotspot resets. Any devices connected to the mobile hotspot are disconnected when the mobile hotspot resets.

Change Wi-Fi Network Names and Passwords From the Mobile Hotspot Web Page

The main and guest Wi-Fi network names identify your Wi-Fi networks and are visible to other Wi-Fi-enabled devices.

The procedure to change the main and guest Wi-Fi network names and passwords is the same. The following settings differ:

- **Main Wi-Fi.** For added security, you can prevent the main Wi-Fi network name and password from displaying on the mobile hotspot's home screen.
- **Guest Wi-Fi.** For added security, you can specify that the guest Wi-Fi password changes each time you enable guest Wi-Fi.

To change network names and passwords from the mobile hotspot web page:

1. From a computer or Wi-Fi device that is connected to the mobile hotspot, launch a web browser.
2. Enter **http://192.168.1.1** or **http://cricketwifi/**.
The mobile hotspot web page displays.
3. Enter the administrator login password.
The default password is **cktadmin**. The password is case-sensitive.
The home page displays.

4. Select **Wi-Fi > Connect**.

The screenshot shows the configuration page for the AirCard 797 Mobile Hotspot. It is divided into two columns: 'Main Wi-Fi' and 'Guest Wi-Fi'.
Main Wi-Fi:
 - Wi-Fi name: CKT-7b7o (3 - 32 characters)
 - Wi-Fi password: k7TbZoz7 (8 - 63 characters)
 - Encryption: WPA2 Personal AES
 - Broadcast Wi-Fi Name (SSID):
 - Wi-Fi Privacy Separator:
Guest Wi-Fi:
 - Wi-Fi name: CKT-7b7o-GUEST (3 - 32 characters)
 - Wi-Fi password: k7TbZoz7 (8 - 63 characters)
 - Generate Passphrase:
 - Encryption: WPA2 Personal AES
 - Broadcast Network Name:
 - Guest Timer: 4 hours

5. Click the **Edit** button for the main Wi-Fi or for the guest Wi-Fi network.

This screenshot is identical to the previous one, but a red rectangular box highlights the entire configuration area for both the Main Wi-Fi and Guest Wi-Fi sections.

6. Change the **Wi-Fi Name** and **Wi-Fi Password** fields as desired.

7. To create a new guest password each time you power on the mobile hotspot, select the **Generate Passphrase** check box.

The Save and Cancel buttons display at the bottom of the page.

8. Click the **Save** button.

A message displays telling you that to save this change, your device must restart Wi-Fi connections.

9. Click the **Save** button.

Your settings are saved.

All devices that were connected must reconnect with the new name and password.

Change Wi-Fi Encryption Settings

For information about Wi-Fi security, see [Security Credentials](#) on page 15.

To change the type of security used for main and secondary or guest Wi-Fi:

1. From a computer or Wi-Fi device that is connected to the mobile hotspot, launch a web browser.
2. Enter **http://192.168.1.1** or **http://cricketwifi/**.
The mobile hotspot web page displays.
3. Enter the administrator login password.
The default password is **cktadmin**. The password is case-sensitive.
The home page displays.
4. Select **Wi-Fi > Connect**.

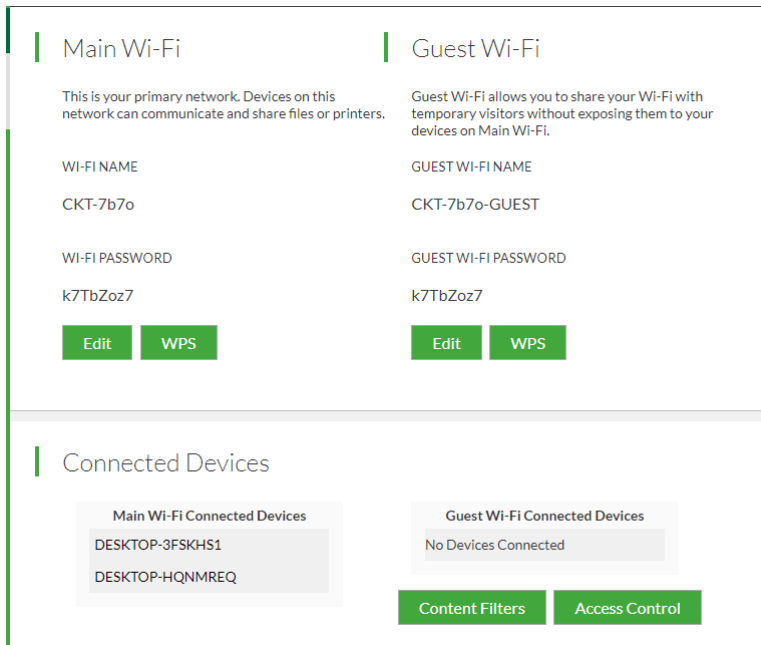

- Click the **Edit** button for the main Wi-Fi or for the guest Wi-Fi network.

The screenshot displays the configuration interface for the AirCard 797 Mobile Hotspot, divided into two sections: Main Wi-Fi and Guest Wi-Fi.

Main Wi-Fi:

- Wi-Fi name: (3 - 32 characters)
- Wi-Fi password: (8 - 63 characters)
- Encryption:
- Broadcast Wi-Fi Name (SSID):
- Wi-Fi Privacy Separator:

Guest Wi-Fi:

- Wi-Fi name: (3 - 32 characters)
- Wi-Fi password: (8 - 63 characters)
- Generate Passphrase:
- Encryption:
- Broadcast Network Name:
- Guest Timer:

- In the Encryption menu for main Wi-Fi or guest Wi-Fi, select a security option:
 - WPA2 Personal AES.** Strong security supported by newer Wi-Fi devices, the default.
 - WPA/WPA2.** Strong security supported by most Wi-Fi devices. Use WPA2 Personal AES whenever possible.
 - None.** Anyone can access your Wi-Fi network without a password and you are responsible for charges incurred. Best practice is not to select this option.

The Save and Cancel buttons display at the bottom of the page.

- Click the **Save** button.

A message displays telling you that to save this change, your device must restart Wi-Fi connections.
- Click the **Save** button.

Your settings are saved.
- Reconnect your Wi-Fi devices, if necessary, using the new Wi-Fi credentials.

3

Manage Security

For information about Wi-Fi security settings, see [Manage Wi-Fi Security](#) on page 33.

The chapter covers the following topics:

- [Change the Mobile Hotspot Web Page Login Settings](#)
- [Content Filter Levels](#)
- [View, Block, or Unblock Connected Devices](#)
- [Set Up an Internet Access Schedule](#)
- [Activate SIM Security](#)
- [Enable Port Forwarding](#)
- [Enable Port Filtering](#)

Change the Mobile Hotspot Web Page Login Settings

You can change the host name for the mobile hotspot web page. You can also change the password to access the mobile hotspot web page.

To change the login settings for the mobile hotspot web page:

1. From a computer or Wi-Fi device that is connected to the mobile hotspot, launch a web browser.
2. Enter **http://192.168.1.1** or **http://cricketwifi/** .
The mobile hotspot web page displays.
3. Enter the administrator login password.
The default password is cktadmin. The password is case-sensitive.
The home page displays.
4. Select **Settings > General > Device**.

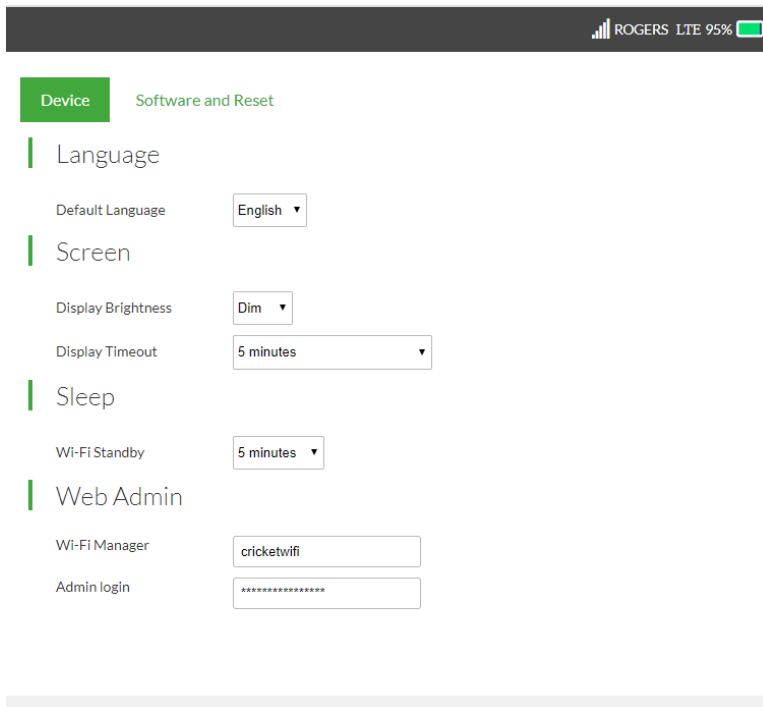

5. In the **Wi-Fi Manager** field, change the URL used to connect to the mobile hotspot. When you change settings, the Save and Cancel buttons display.
6. In the **Admin login** field, change the password used to log in as an administrator.

Best practice is to set a more secure password.

Enter a maximum of 31 characters.

7. Click the **Save** button .
Your settings are saved.

Content Filter Levels

You can set up content filtering levels on the mobile hotspot with a free OpenDNS account. Content filters provide parental controls and phishing protection.

Set Up Content Filtering

To enable content filtering, you must log in to the mobile hotspot web page and be connected to the Internet.

To enable content filtering:

1. From a computer or Wi-Fi device that is connected to the mobile hotspot, launch a web browser.
2. Enter **http://192.168.1.1** or **http://cricketwifi/**.
The mobile hotspot web page displays.
3. Enter the administrator login password.
The default password is **cktadmin**. The password is case-sensitive.
The home page displays.
4. Select **Security > Content Filters**.
The Content Filters page displays.
5. Select the **Content Filters** button.

AirCard 797 Mobile Hotspot

Content Filters Website Filters

Content Filters

NETGEAR content filtering, powered by OpenDNS, makes the Internet safer for your household or business. By creating a free account with OpenDNS, you will have parental controls and phishing protection for all of your devices connected to the mobile hotspot.

Username

Password

Login

Forgot password

Don't have an OpenDNS account? [Sign Up](#)

6. If you do not have an OpenDNS account, do the following:
 - a. Click the **Sign Up** link.

Sign Up

Information Default Filter Level

Username You will be able to change or customize the settings after you sign in.

Email

Password

Confirm Password

Your password must be between 8 to 256 characters long. It should include at least one uppercase letter, lowercase letter, digit, and a special character (e.g. *, \$). Password must not contain part of your username.

None - nothing blocked

Minimal - blocks phishing sites

Low - blocks phishing and pornography

Moderate - blocks all adult-related sites, illegal activity and phishing

High - blocks social networks, video sharing, general time wasters, adult related sites, illegal activity and phishing

Sign Up

- b. Complete the fields to create your OpenDNS account.
 - c. Click the **Sign Up** button.
7. If you already have an OpenDNS account, enter the user name and password.
8. When prompted, select a **Filter Level** radio button.
9. Click the **Save** button.
Your settings are saved.

Block Access to Websites

You can use website filters to block access to websites that you specify. You can also allow unrestricted access on specific computers and devices.

To block access to a website:

1. From a computer or Wi-Fi device that is connected to the mobile hotspot, launch a web browser.
2. Enter **http://192.168.1.1** or **http://cricketwifi/**.
The mobile hotspot web page displays.
3. Enter the administrator login password.
The default password is **cktadmin**. The password is case-sensitive.
The home page displays.
4. Select **Security > Content Filters > Website Filters**.

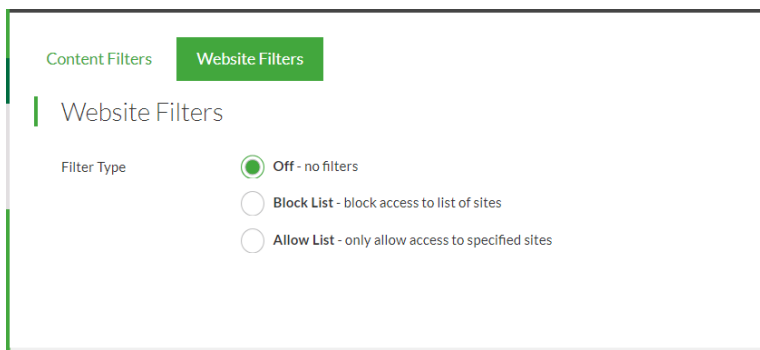

5. Select the **Block List - block access to list of sites** radio button.
The page adjusts.
6. Enter the website in the **Site Name** field and click the **+** button.
7. To allow unrestricted access on specific computers or devices, complete the **Name** and **MAC Address** fields and click the **+** button.
8. Click the **Save** button.
Your settings are saved.

Allow Access to Websites

You can use website filters to set up a list of websites that can be accessed through the mobile hotspot broadband Internet connection. You can also allow unrestricted access to specific computers and devices.

To set up website filters:

1. From a computer or Wi-Fi device that is connected to the mobile hotspot, launch a web browser.
2. Enter **http://192.168.1.1** or **http://cricketwifi/** .
The mobile hotspot web page displays.
3. Enter the administrator login password.
The default password is **cktadmin**. The password is case-sensitive.
The home page displays.
4. Select **Security > Content Filters > Website Filters**.

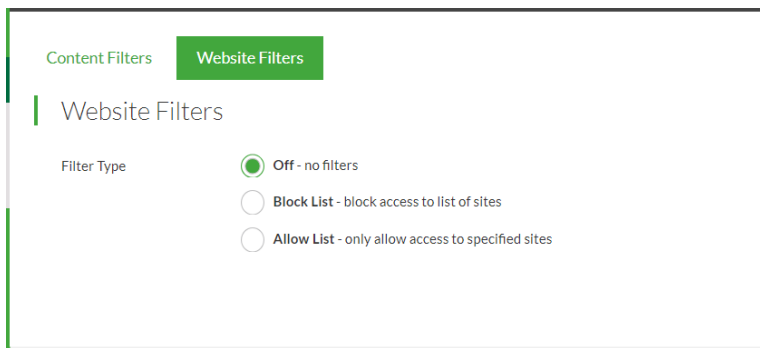

5. Select the **Allow List - only allow access to specified sites** radio button.
The page adjusts.
6. Enter the website in the **Site Name** field and click the **+** button.
7. To allow unrestricted access on specific computers or devices, complete the **Name** and **MAC Address** fields and click the **+** button.
8. Click the **Save** button.
Your settings are saved.

View, Block, or Unblock Connected Devices

You can block specific devices from connecting to the mobile hotspot.

View Connected Devices From the Mobile Hotspot Web Page

To view the connected devices from the mobile hotspot web page:

1. From a computer or Wi-Fi device that is connected to the mobile hotspot, launch a web browser.
2. Enter **http://192.168.1.1** or **http://cricketwifi/**.
The mobile hotspot web page displays.
3. Enter the administrator login password.
The default password is **cktadmin**. The password is case-sensitive.
The home page displays.
4. Select **Wi-Fi > Connect**.

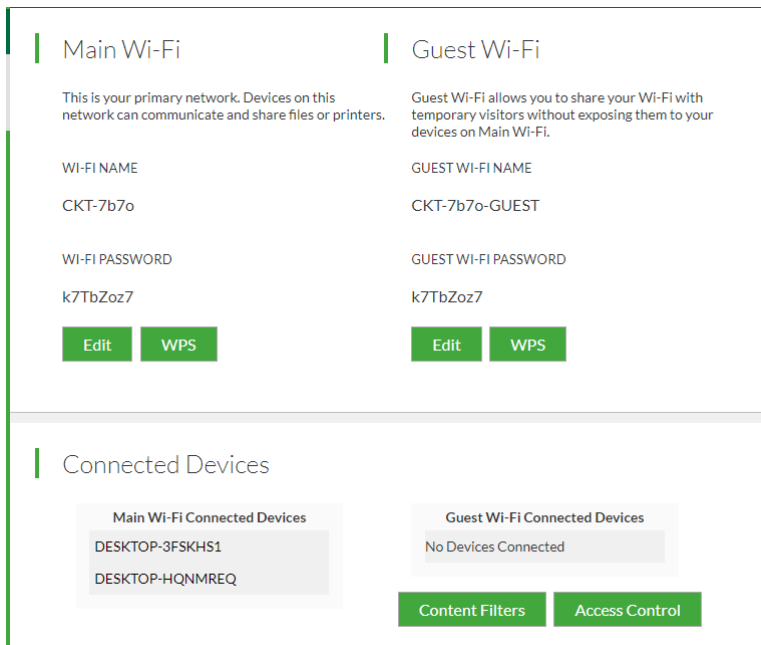

The Connected Devices section of the page displays a list of devices connected to your network. If you notice a Wi-Fi device that you do not recognize, you can block that device from connecting to your Wi-Fi network.

Block a Device From the Mobile Hotspot Web Page

To block device access:

1. From a computer or Wi-Fi device that is connected to the mobile hotspot, launch a web browser.
2. Enter **http://192.168.1.1** or **http://cricketwifi/**.
The mobile hotspot web page displays.
3. Enter the administrator login password.
The default password is **cktadmin**. The password is case-sensitive.
A list of devices connected to the main Wi-Fi and guest Wi-Fi networks displays on the home page.
4. Click the device name.
The device details display.
5. Click the **Block Device** button.
6. When prompted, click the **Block Device** button again.
The device is blocked from your network.

Unblock a Device From the Mobile Hotspot Web Page

To unblock a device from the mobile hotspot web page:

1. From a computer or Wi-Fi device that is connected to the mobile hotspot, launch a web browser.
2. Enter **http://192.168.1.1** or **http://cricketwifi/**.
The mobile hotspot web page displays.
3. Enter the administrator login password.
The default password is **cktadmin**. The password is case-sensitive.
The home page displays.
A list of devices connected to the main Wi-Fi and guest Wi-Fi networks displays in the right column of the page.
4. Select **Security > Access Control**.
The MAC Filter page displays.
5. From the **MAC Filter Mode** menu, select **Black list**.
The list of blocked devices displays.

6. Click the **x** button next to the device.
The device can access your network.

View a List of Blocked Devices From the Mobile Hotspot Web Page

To view a list of blocked devices from the mobile hotspot web page:

1. From a computer or Wi-Fi device that is connected to the mobile hotspot, launch a web browser.
2. Enter **http://192.168.1.1** or **http://cricketwifi/**.
The mobile hotspot web page displays.
3. Enter the administrator login password.
The default password is **cktadmin**. The password is case-sensitive.
The home page displays.
4. To view a list of connected devices, select **Wi-Fi > Connect**.
5. Select **Security > Access Controls**.
The Access Control page displays.
6. From the **MAC Filter Mode** menu, select **Block list**.
The list of blocked devices displays.

Set Up an Internet Access Schedule

You can restrict which times during the week you allow Internet access. When you set up an access schedule, the Internet access is restricted except for the times you specify in schedule rules. Schedule rules automatically repeat weekly. When the Internet access is blocked according to the schedule, an alert icon displays on the main screen. In this mode, you can still connect to the mobile hotspot over Wi-Fi to view status or configure the mobile hotspot.

To set up an Internet access schedule from the mobile hotspot web page:

1. From a computer or Wi-Fi device that is connected to the mobile hotspot, launch a web browser.
2. Enter **http://192.168.1.1** or **http://cricketwifi/**.
The mobile hotspot web page displays.
3. Enter the administrator login password.

The default password is **cktadmin**. The password is case-sensitive.
The home page displays.

4. Select **Security > Schedule**.

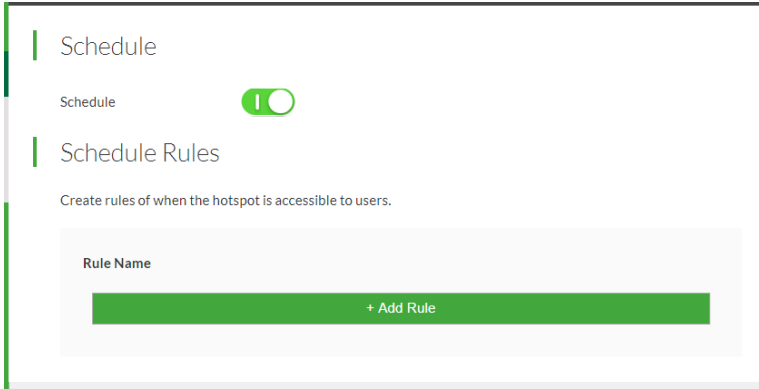

5. Select the **Schedule** button.
6. Click the **Add Rule** button.

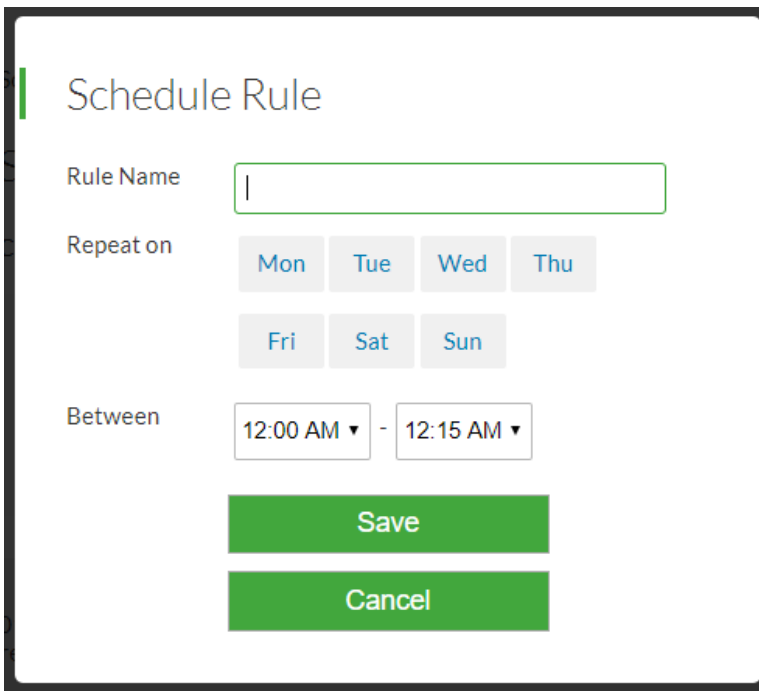

7. Enter a name for the rule and select the days and times when you want to allow connections to the mobile hotspot network.
8. Click the **Save** button.
Your settings are saved.

Activate SIM Security

You can create another level of security by establishing a PIN that you must enter before you can manage the network connection or view SMS messages.

To activate SIM security:

1. From a computer or Wi-Fi device that is connected to the mobile hotspot, launch a web browser.
2. Enter **http://192.168.1.1** or **http://cricketwifi/**.
The mobile hotspot web page displays.
3. Enter the administrator login password.
The default password is **cktadmin**. The password is case-sensitive.
The home page displays.
4. Select **Settings > Mobile Broadband > SIM Security**.
The SIM Security page displays.
5. Click the **Activate** button.
6. Enter your PIN and click the **Save** button.
If you enter an incorrect PIN three times, the SIM is blocked. If the SIM is blocked, contact your network service provider to receive a PUK number to unblock the SIM.

Enable Port Forwarding

If your computer is hosting a server, you can enable port forwarding so that other users can access the server. With port forwarding, incoming traffic is forwarded to specific ports and devices on your network using their local IP addresses.

Note: Port forwarding creates a security risk. When not required, leave port forwarding disabled.

To enable port forwarding:

1. From a computer or Wi-Fi device that is connected to the mobile hotspot, launch a web browser.
2. Enter **http://192.168.1.1** or **http://cricketwifi/**.
The mobile hotspot web page displays.
3. Enter the administrator login password.

The default password is **cktadmin**. The password is case-sensitive.
The home page displays.

4. Select **Settings > Router > Port Forwarding**.

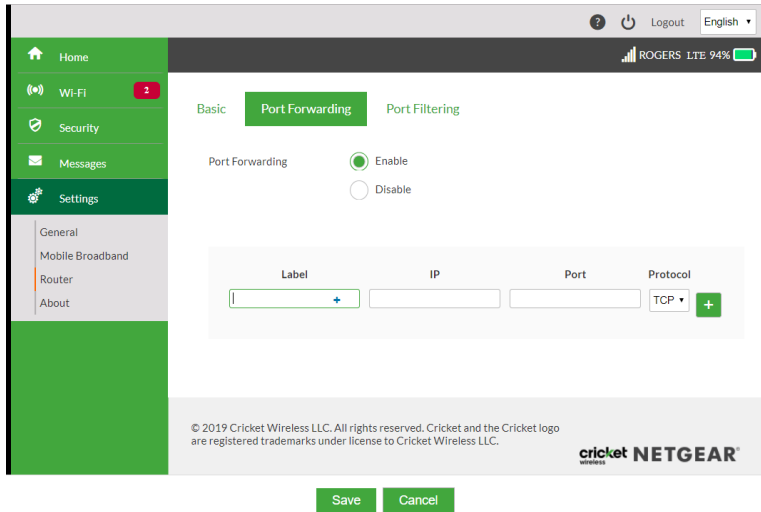

5. Select the **Enable** radio button .

The page adjusts.

6. Enter the following port forwarding information:

- **Label.** Enter a descriptive name.
- **IP.** Enter the IP address of a connected device.
- **Port.** Enter the port number that the application uses.
- **Protocol.** If you are unsure, select TCP.

7. Click the **Save** button.

Your settings are saved.

Enable Port Filtering

You can select which applications (for example, HTTP, FTP, email servers) can access the Internet. Used with other security measures such as a firewall, port filtering can enhance network security.

To enable port filtering:

1. From a computer or Wi-Fi device that is connected to the mobile hotspot, launch a web browser.
2. Enter **http://192.168.1.1** or **http://cricketwifi/**.
The mobile hotspot web page displays.
3. Enter the administrator login password.
The default password is **cktadmin**. The password is case-sensitive.
The home page displays.
4. Select **Settings > Router > Port Filtering**.

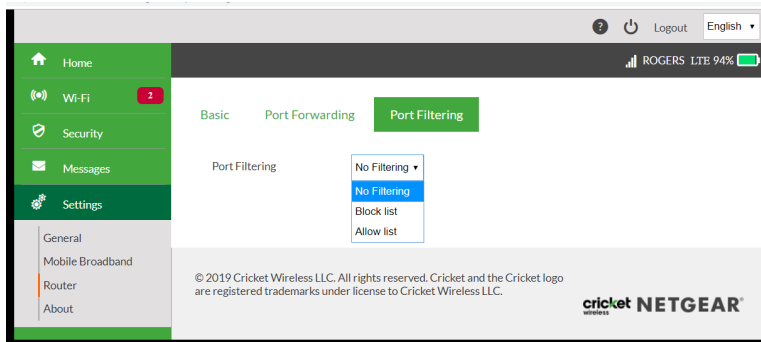

5. From the **Port Filtering** list, select one of the following:
 - **Block List.** Specific applications and services are not allowed to access the Internet (block list).
 - **Allow List.** Only specific applications and services are allowed to access the Internet (allow list).

Only one list at a time can be active, either a block list or an allow list.

6. Identify the ports to filter.
Enter a meaningful label that describes the application or service.
7. Enter the port being used.
8. Enter the communication protocol being used.
9. Click the **Save** button.
Your settings are saved.

4

Maintain Your Mobile Hotspot

The chapter covers the following topics:

Extend Battery Life

The mobile hotspot, by default, is configured to optimize battery life. The following factors affect battery life:

- Screen brightness.
- Standby time.
- Data throughput.
- Mobile broadband signal strength (the better the signal, the longer the battery life).
- Wi-Fi range.
- Dual-band Wi-Fi (when all of your devices support 5 GHz Wi-Fi, dual-band Wi-Fi allows faster downloads but uses more power).
- Guest Wi-Fi, when enabled, uses more power.

To extend the battery life, use any of the following methods:

- Adjust Wi-Fi settings.
- Adjust display settings.
- Use tethered USB.

Adjust Wi-Fi Settings to Optimize Battery Life

If the devices that you are connecting to your Wi-Fi network are always close to your mobile hotspot, shorten the Wi-Fi range. Set the standby timer to a shorter period to minimize the wait time when no devices are connected to either Wi-Fi network before going into standby mode (the Wi-Fi radios turn off).

Note: When you change the Wi-Fi settings, any devices connected to the mobile hotspot are disconnected and might need to be reconnected.

You can set the following Wi-Fi options to optimize battery life:

- Adjust the display settings. See [Adjust Display Settings to Increase Battery Life](#) on page 52.
- Set the Wi-Fi range to Standard, not Extended, and set the Wi-Fi standby to 5 minutes.

Adjust Display Settings to Increase Battery Life

Dim the screen to reduce the LCD screen's brightness level. Set the screen time-out to a shorter period to reduce the amount of time the mobile hotspot waits without the LCD screen being touched before the screen turns blank.

To adjust display settings to increase battery life from the mobile hotspot web page:

1. From a computer or Wi-Fi device that is connected to the mobile hotspot, launch a web browser.
2. Enter **http://192.168.1.1** or **http://cricketwifi/**.
The mobile hotspot web page displays.
3. Enter the administrator login password.
The default password is **cktadmin**. The password is case-sensitive.
The home page displays.
4. Select **Settings > General > Device**.
The device settings page opens.
5. Adjust any of these settings:
 - **Display Brightness** . From the menu, select the display brightness level.
 - **Display Timeout** . From the menu, select a shorter time period.
6. Click the **Save** button.
Your settings are saved.

View Details About Your Mobile Hotspot

You can view details about your device such as the model number, software version, and IMEI (International Mobile Station Equipment Identity).

To view details about your device from the mobile hotspot web page:

1. From a computer or Wi-Fi device that is connected to the mobile hotspot, launch a web browser.
2. Enter **http://192.168.1.1** or **http://cricketwifi/**.
The mobile hotspot web page displays.
3. Enter the administrator login password.
The default password is **cktadmin**. The password is case-sensitive.

The home page displays.

4. Select **Settings > About**.

The screenshot displays the 'About' page of the AirCard 797 Mobile Hotspot. The page is organized into several sections, each with a green vertical bar on the left. The sections are: Account Details, Wi-Fi Details, Firmware, Open Source, Device, and Network Status. A green 'Save to File' button is located at the bottom left of the page.

Account Details

- Wireless number +1 (604) 375-5036
- MAC Address 3C-37-86-AB-C3-FC
- IMEI: 015339000000187
- IMEI SV 02
- FSN 5WS18CNU00013
- ICCID 89302720403064607020

Wi-Fi Details

- Wi-Fi name CKT-7b7o
- Wi-Fi password k7TbZoz7
- Guest Wi-Fi name CKT-7b7o-GUEST
- Guest Wi-Fi password k7TbZoz7
- MAC Address 3C-37-86-AB-C3-FC
- IP Address 25.161.57.118
- Encryption WPA2_Personal_AES
- Wi-Fi Devices 2
- Max Wi-Fi Devices 14
- Max Guest Wi-Fi Devices 1
- Wi-Fi Range Short
- Broadcast Wi-Fi Name (SSID) On

Firmware

- FW Version NTG9X40C_30.00.08.01
- FW Build Date 2019/01/25
- Web App Version AC7975-1CKNAS_03.04.79.00
- Bootloader Version NTG9X40C_30.00.08.01

Open Source

- [View Credits & Licenses](#)

Device

- Model AirCard 797S
- Wi-Fi Manager <http://cricketwifi>
- FW Version NTG9X40C_30.00.08.01
- FW Build Date 2019/01/25
- PRI Version 01.08
- Power State Online
- Current temperature 29 °C
- Current voltage: 4175mV
- Battery charge level 93
- Battery status Normal
- Battery temperature: 30 °C

Network Status

- Network Status Connected
- RSRP -95 dBm
- RSRQ -13 dBm
- RS-SINR 25 dBm
- Current radio band LTE B2
- Quality 46 dB
- PS service type LTE
- Network selection mode Auto
- Country CAN
- Roaming False
- Network ROGERS
- MCC 302
- MNC 720
- LAC 35200
- RAC 240
- Cell ID 102509069
- Channel Number 1025
- MNC format 3
- PLMN service error bit mask 0
- IP Address 25.161.57.118
- IPv6 Address
- MTU Size 1430

Save to File

Back Up and Restore Mobile Hotspot Settings

You can back up and restore mobile hotspot settings. Backing up and restoring are useful if you use more than one device and you want the same settings on all of your devices. You can also save your settings before resetting to factory defaults or changing the settings.

Back Up Mobile Hotspot Settings Using the Web Page

To back up mobile hotspot settings using the web page:

1. From a computer or Wi-Fi device that is connected to the mobile hotspot, launch a web browser.
2. Enter **http://192.168.1.1** or **http://cricketwifi/**.
The mobile hotspot web page displays.
3. Enter the administrator login password.
The default password is **cktadmin**. The password is case-sensitive.
The home page displays.
4. >Select Settings > General > Software and Reset.

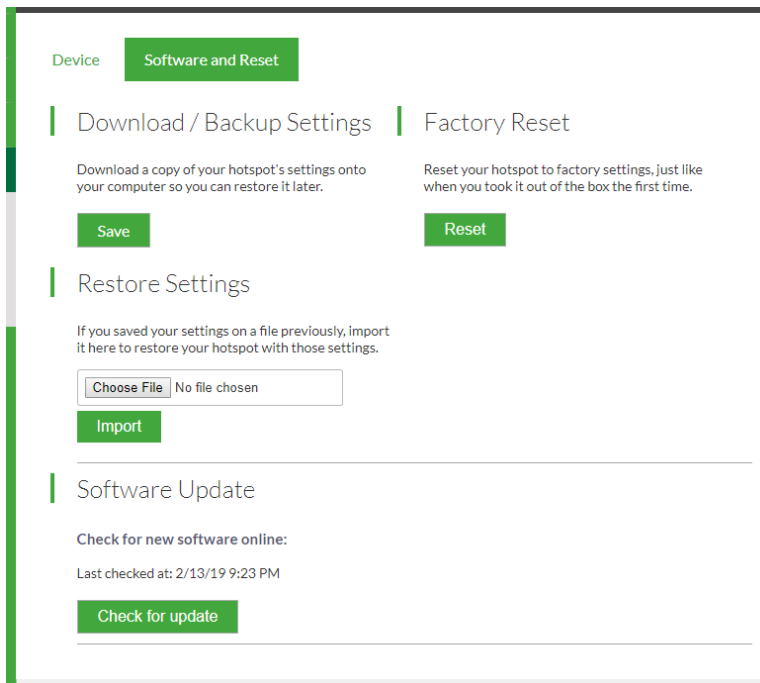

5. Click the **Export** button.
By default, the file (export.cfg) is saved to your Downloads folder.

Restore Mobile Hotspot Settings Using the Web Page

To restore mobile hotspot settings:

1. From a computer or Wi-Fi device that is connected to the mobile hotspot, launch a web browser.
2. Enter **http://192.168.1.1** or **http://cricketwifi/**.
The mobile hotspot web page displays.
3. Enter the administrator login password.
The default password is **cktadmin**. The password is case-sensitive.
The home page displays.
4. Select **Settings > General > Software and Reset**.

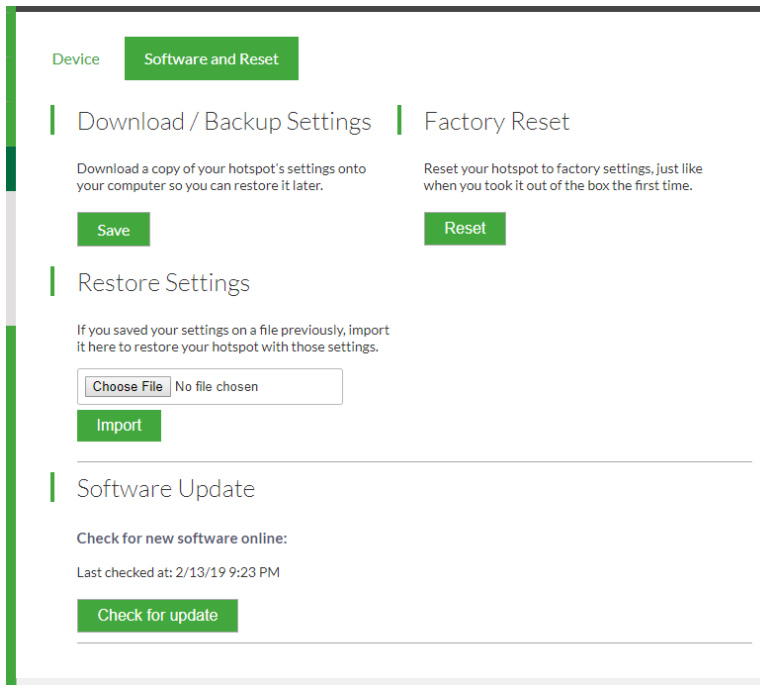

5. Click the **Choose File** button.
6. Navigate to the location where the export.cfg file is stored and select it.
By default, mobile hotspot setting files are saved to your Downloads folder.
7. Click the **Import** button.
Your mobile hotspot is restored with the imported file settings.

Restore Mobile Hotspot Settings Using the LCD Display

Start with the mobile hotspot turned on.

To restore mobile hotspot settings directly from the mobile hotspot:

1. Press and hold the **power** button for at least 15 seconds.
The mobile hotspot enters factory reset mode and first displays the message, "Shutting down," followed by the message "Continue holding Power button to reset all settings to factory default," and then "Resetting Device. Please do not power off."

Note: If you release the **power** button too soon, the mobile hotspot turns off instead of resetting.

Configure Mobile Broadband

You can configure mobile broadband settings to view WAN details such as the active network, connection status, and signal strength. You can also adjust these settings to establish which users and applications can access your network.

Enable IP Pass-Through Mode

To turn off the mobile hotspot router functionality and assign the network IP address directly to the attached device, enable IP pass-through.

If you make this change, the attached device restarts using a different driver configuration.

WARNING: If you enable this feature, Wi-Fi is disabled and you must use a USB cable to tether the device.

Note: This feature is available to Windows computer users. If you are a Mac user, do not enable this option because you will be unable to access your device.

To enable IP pass-through mode:

1. From a computer or Wi-Fi device that is connected to the mobile hotspot, launch a web browser.
2. Enter **http://192.168.1.1** or **http://cricketwifi/**.
The mobile hotspot web page displays.
3. Enter the administrator login password.

The default password is **cktadmin**. The password is case-sensitive.
The home page displays.

4. Select **Settings > Router > Basic**.

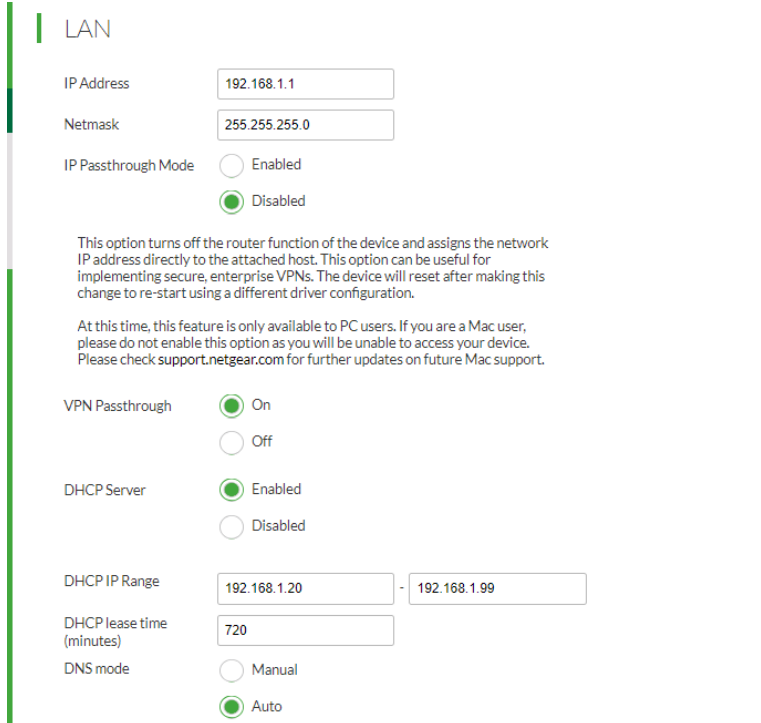

LAN

IP Address

Netmask

IP Passthrough Mode Enabled
 Disabled

This option turns off the router function of the device and assigns the network IP address directly to the attached host. This option can be useful for implementing secure, enterprise VPNs. The device will reset after making this change to re-start using a different driver configuration.

At this time, this feature is only available to PC users. If you are a Mac user, please do not enable this option as you will be unable to access your device. Please check support.netgear.com for further updates on future Mac support.

VPN Passthrough On
 Off

DHCP Server Enabled
 Disabled

DHCP IP Range -

DHCP lease time (minutes)

DNS mode Manual
 Auto

5. In the LAN section, select the IP Passthrough Mode **Enabled** radio button.
6. Click the **Save** button.

Enable VPN Pass-Through

To connect to a corporate network using VPN, you must first enable VPN connections (pass-through).

To enable VPN pass-through:

1. From a computer or Wi-Fi device that is connected to the mobile hotspot, launch a web browser.
2. Enter **http://192.168.1.1** or **http://cricketwifi/**.
The mobile hotspot web page displays.
3. Enter the administrator login password.
The default password is **cktadmin**. The password is case-sensitive.
The home page displays.

4. Select **Settings > Router > Basic**.

LAN

IP Address

Netmask

IP Passthrough Mode Enabled
 Disabled

This option turns off the router function of the device and assigns the network IP address directly to the attached host. This option can be useful for implementing secure, enterprise VPNs. The device will reset after making this change to re-start using a different driver configuration.

At this time, this feature is only available to PC users. If you are a Mac user, please do not enable this option as you will be unable to access your device. Please check support.netgear.com for further updates on future Mac support.

VPN Passthrough On
 Off

DHCP Server Enabled
 Disabled

DHCP IP Range -

DHCP lease time (minutes)

DNS mode Manual
 Auto

5. In the LAN section, select the VPN Passthrough **On** radio button.
6. Click the **Save** button.
Your settings are saved.

Configure APN Details

Your mobile hotspot comes preconfigured with the access point name (APN) for your network service provider.

The mobile hotspot checks the APN to determine the type of network connection to establish.

Add an APN for Another Network To add an APN for another network:

1. From a computer or Wi-Fi device that is connected to the mobile hotspot, launch a web browser.
2. Enter **http://192.168.1.1** or **http://cricketwifi/**.
The mobile hotspot web page displays.
3. Enter the administrator login password.
The default password is **cktadmin**. The password is case-sensitive.
The home page displays.

4. Select **Settings > Mobile Broadband > APN**.

The APN screen displays.

5. Click the **Add** button.

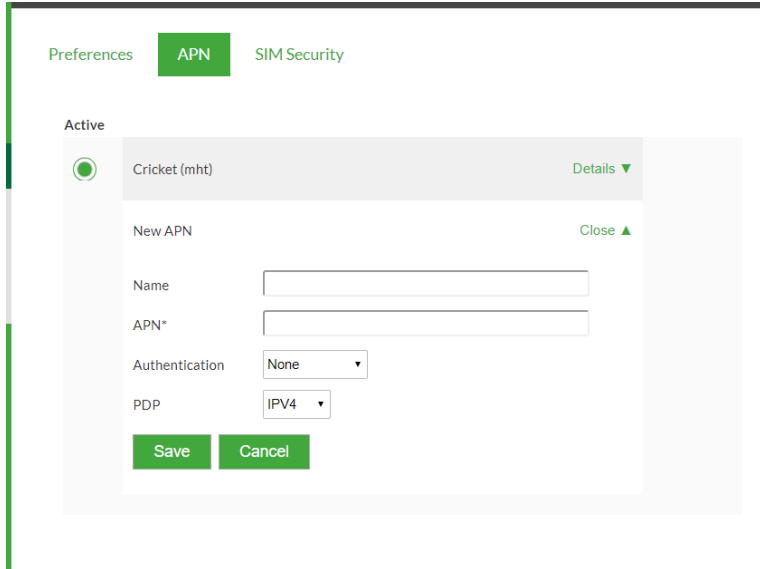

6. Enter the name and password, if they are required for the network.

7. Select the network authentication mode:

- **None**
- **PAP**
- **CHAP**
- **PAP or CHAP**

8. Change the PDP (data protocol), if necessary:

- **IPV4**
- **IPV6**
- **IPV4V6**

9. Click the **Save** button.

The entry is added to the table.

Select an APN to Use To select an APN to use:

1. From a computer or Wi-Fi device that is connected to the mobile hotspot, launch a web browser.
2. Enter **http://192.168.1.1** or **http://cricketwifi/**.

The mobile hotspot web page displays.

3. Enter the administrator login password.
The default password is **cktadmin**. The password is case-sensitive.
The home page displays.
4. Select **Settings > Mobile Broadband > APN**.

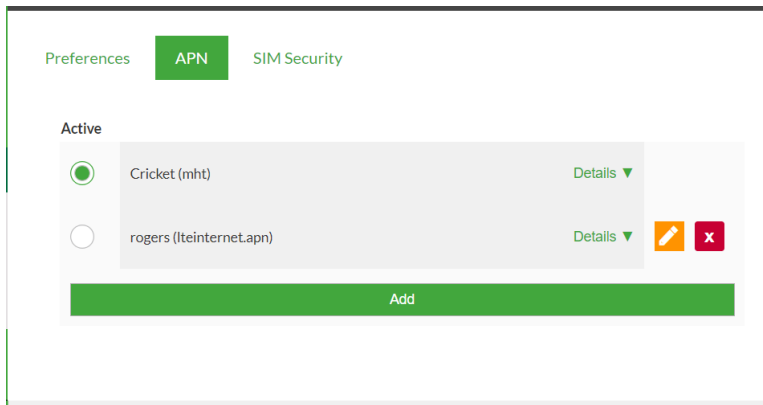

5. Select the **Active** radio button next to the APN entry.
The APN is selected.

Remove an APN Entry To remove an APN entry:

1. From a computer or Wi-Fi device that is connected to the mobile hotspot, launch a web browser.
2. Enter **http://192.168.1.1** or **http://cricketwifi/**.
The mobile hotspot web page displays.
3. Enter the administrator login password.
The default password is **cktadmin**. The password is case-sensitive.
The home page displays.

4. Select **Settings > Mobile Broadband > APN**.

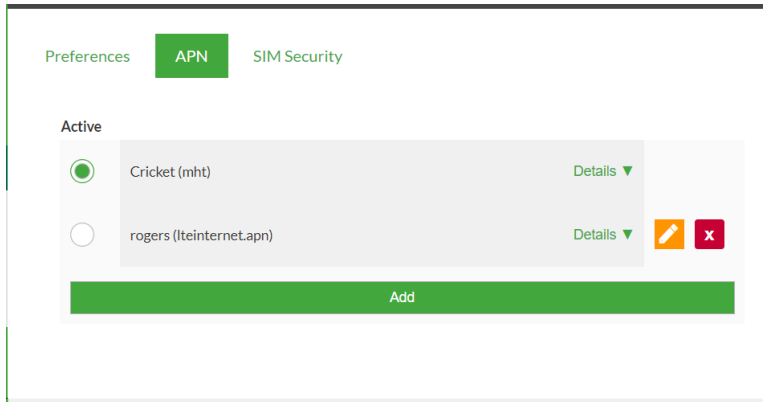

5. Click the **Delete** button.
The APN is removed.

Enable DMZ

In a demilitarized zone (DMZ) network configuration, a computer runs outside the firewall in the DMZ. This computer intercepts incoming Internet traffic, providing an extra layer of protection for the rest of the network, and sending all incoming data to a particular IP address.

To enable the DMZ and designate a computer to screen incoming traffic:

1. From a computer or Wi-Fi device that is connected to the mobile hotspot, launch a web browser.
2. Enter **http://192.168.1.1** or **http://cricketwifi/**.
The mobile hotspot web page displays.
3. Enter the administrator login password.
The default password is **cktadmin**. The password is case-sensitive.
The home page displays.
4. Select **Settings > Router > Basic**.
The Router Basic page displays.

5. Scroll down to display the DMZ section.

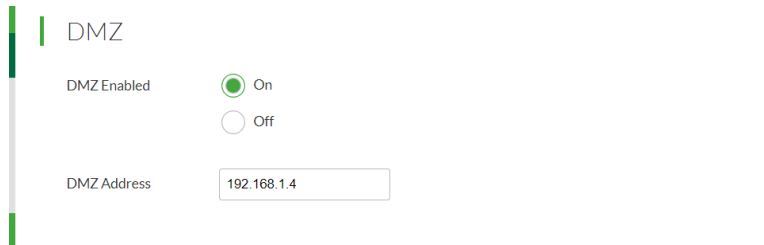

6. Select the DMZ Enabled **On** radio button.
7. In the **DMZ Address** field, enter the IP address of the computer to which you want all data sent.
If the mobile hotspot is tethered using a USB cable, this address is 192.168.1.4. If the mobile hotspot is connected using Wi-Fi, the first Wi-Fi client's IP address is usually 192.168.1.74.
8. Click the **Save** button.
Your settings are saved.

Set LAN Options

To set the mobile hotspot's LAN options:

1. From a computer or Wi-Fi device that is connected to the mobile hotspot, launch a web browser.
2. Enter **http://192.168.1.1** or **http://cricketwifi/**.
The mobile hotspot web page displays.
3. Enter the administrator login password.
The default password is **cktadmin**. The password is case-sensitive.
The home page displays.

4. Select **Settings > Router > Basic**.

LAN

IP Address

Netmask

IP Passthrough Mode Enabled
 Disabled

This option turns off the router function of the device and assigns the network IP address directly to the attached host. This option can be useful for implementing secure, enterprise VPNs. The device will reset after making this change to re-start using a different driver configuration.

At this time, this feature is only available to PC users. If you are a Mac user, please do not enable this option as you will be unable to access your device. Please check support.netgear.com for further updates on future Mac support.

VPN Passthrough On
 Off

DHCP Server Enabled
 Disabled

DHCP IP Range -

DHCP lease time (minutes)

DNS mode Manual
 Auto

5. In the LAN section, enter the appropriate details.

If the DHCP server is enabled, it automatically assigns an IP address to each device on the network and manages its configuration information.

The DNS mode setting specifies how the DNS servers are obtained. If you select the **Auto** radio button, the servers use the DNS relay specified by the Internet provider.

6. Click the **Save** button.

Your settings are saved.

Update Mobile Hotspot Software and Firmware

The mobile hotspot automatically checks for new software or firmware updates once a week. If an update becomes available, the mobile hotspot displays an alert. You can also check for updates manually without receiving an alert.

Update in Response to an Alert

To update the mobile hotspot software or firmware in response to an alert:

1. To wake the device, press the **Power** button.
The home screen displays.
2. Press the **Power** button again.
The alert message displays.
3. Press and hold the **Power** button.
The update process starts.
After the update install completes, the mobile hotspot reboots.

Update Software From the Mobile Hotspot Web Page

To update software from the mobile hotspot web page:

1. From a computer or Wi-Fi device that is connected to the mobile hotspot, launch a web browser.
2. Enter **http://192.168.1.1** or **http://cricketwifi/**.
The mobile hotspot web page displays.
3. Enter the administrator login password.
The default password is **cktadmin**. The password is case-sensitive.
The home page displays.

4. Select **Settings > General > Software and Reset**.

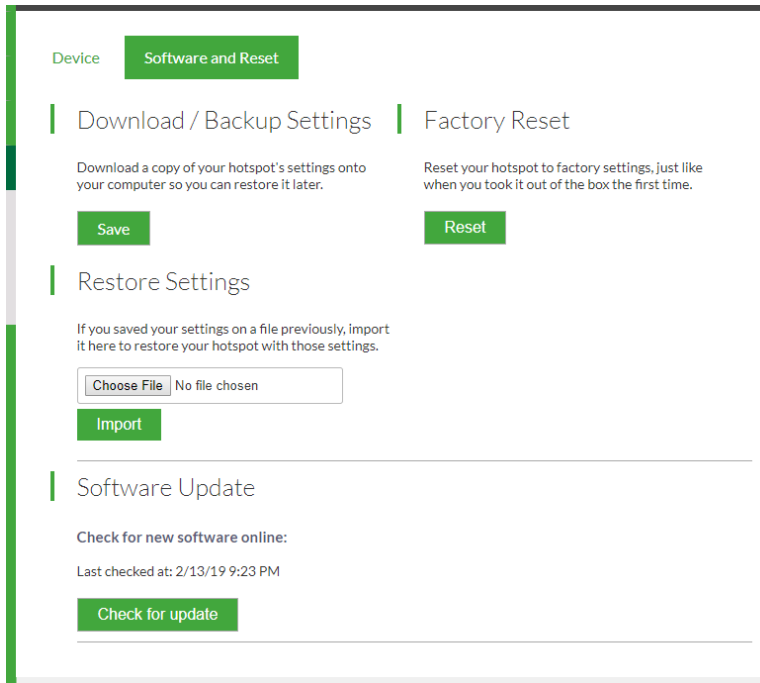

5. If the **Check for update** button displays, click it to see if a new update is available.
6. If an update is available, click the **Start Download** button.
The update downloads.
7. Click the **Update now** button to install the update.
After the update install completes, the mobile hotspot reboots.

5

Frequently Asked Questions

This chapter provides answers to possible questions about your mobile hotspot:

- [Questions About Connecting and Disconnecting Devices and Accessing the Internet](#)
- [Questions About the Mobile Hotspot Web Page](#)
- [General Questions](#)

Questions About Connecting and Disconnecting Devices and Accessing the Internet

Review these topics for answers to questions about connecting and disconnecting devices and accessing the Internet.

What do I do if I can't connect a device to the mobile hotspot?

If you are experiencing problems connecting to the mobile hotspot, try the following suggestions:

- Turn off your mobile hotspot and take the battery out, wait 10 seconds, put the battery back in, and turn your mobile hotspot on.
- Restart your computer.
- Turn off or temporarily disable any security programs or firewalls.
- If possible, try using another computer or Wi-Fi device to connect to your mobile hotspot. If you can, then the problem is with the device that cannot connect, not the mobile hotspot.

What do I do if I can't access the Internet?

If you are connected to the mobile hotspot but cannot connect to the Internet, try the following suggestions:

- Check the display status on the mobile hotspot's LCD screen.
- Make sure that network coverage is available in your area.
- Make sure that your micro SIM card is active and enabled with data services.
- Wait one to two minutes for the mobile hotspot to initialize.
- Confirm that your account is activated and that no other Internet connections are active.
- Switch your mobile hotspot off and on and restart your computer or Wi-Fi device.

How do I disconnect from the mobile broadband network?

Turning off domestic data disconnects your mobile hotspot from the mobile broadband network. For more information, see [Turn Domestic Data On and Off From the Mobile Hotspot Web Page](#) on page 23.

Why doesn't the Connect or Disconnect button appear on the mobile hotspot web page?

You can use the **Connect** or **Disconnect** button only when you are logged in as an administrator.

To log in as an administrator:

1. From a computer or Wi-Fi device that is connected to the mobile hotspot, launch a web browser.
2. Enter **http://192.168.1.1** or **http://cricketwifi/**.
The mobile hotspot web page displays.
3. Enter the password in the **Sign In** field.
The default password is **cktadmin**. The password is case-sensitive.
4. Click the **Sign In** button.
The home page displays.

How do I find out how many devices are connected to my mobile hotspot's Wi-Fi networks?

The number next to the **Wi-Fi** button on the mobile hotspot's LCD home screen is the number of users (or devices) connected to your Wi-Fi network. When you log in to the mobile hotspot web page, the number of connected devices displays on the home page.

What do I do if the No Signal icon displays?

If the No Signal icon () displays, make sure that you are in your network service provider's coverage area.

Why can't my device access the mobile hotspot web page when connected to a VPN?

If you are using your mobile hotspot while connected to a VPN, you might not be able to access the mobile hotspot web page using **http://192.168.1.1** or **http://cricketwifi/**.

To directly access the mobile hotspot web page hosted on the device, enter the address **http://192.168.1.1** in your browser.

Why can't my mobile hotspot connect to a computer running Windows Vista?

A known issue exists whereby computers running Microsoft Windows Vista cannot obtain an IP address from certain routers. More information and a fix are available at <http://support.microsoft.com/kb/928233>, or visit the Microsoft support website and search for knowledge base article 928233.

What do I do if my mobile hotspot doesn't connect to my service provider's network?

If your mobile hotspot does not connect to your service provider's mobile broadband network, try the following suggestions:

- Make sure that your micro SIM account is active. To check micro SIM status, contact your wireless service provider.
- If you use a prepaid micro SIM card, make sure that the account balance is positive.
- If your mobile hotspot still does not connect, you might need to create or update the default connection profile.

To check the default connection profile settings:

1. From a computer or Wi-Fi device that is connected to the mobile hotspot, launch a web browser.
2. Enter **http://192.168.1.1** or **http://cricketwifi/**.
The mobile hotspot web page displays.
3. Enter the mobile hotspot password.
The default password is **cktadmin**. The password is case-sensitive.
The home page displays.

4. Select **Settings > Mobile Broadband > APN**.

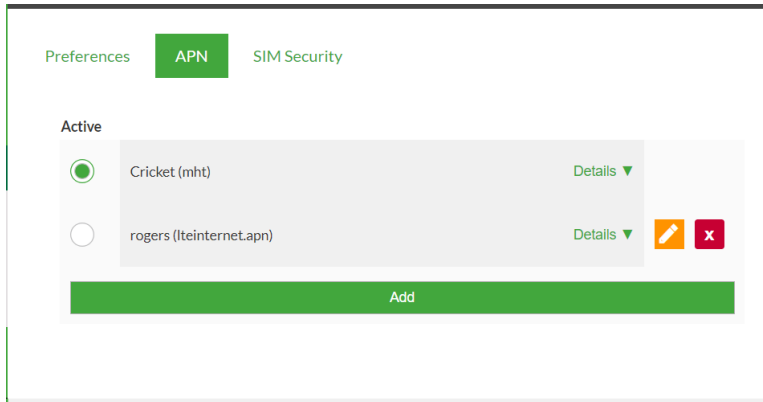

5. Review ISP settings.

Questions About the Mobile Hotspot Web Page

Review these topics for answers to questions about the mobile hotspot web page.

How do I go back to the mobile hotspot web page?

To view the mobile hotspot web page:

1. From a computer or Wi-Fi device that is connected to the mobile hotspot, launch a web browser.
2. Enter **http://192.168.1.1** or **http://cricketwifi/**.
The mobile hotspot web page displays.
3. Enter the administrator login password.
The default password is **cktadmin**. The password is case-sensitive.
The mobile hotspot web page displays.

What do I do if I forget my admin login password?

The default admin login password is **cktadmin**, and the mobile hotspot web page URL is **http://192.168.1.1** or **http://cricketwifi/**.

If you changed the admin login password and can't remember the password that you created, you must reset the mobile hotspot back to factory defaults. See [Reset the Mobile Hotspot](#) on page 79.

General Questions

Review these topics for answers to general questions about the mobile hotspot.

Why isn't my battery charging?

If you are in a low-coverage area, are transferring a lot of data, or left the mobile hotspot in a hot location, the internal temperature of the mobile hotspot can rise above 45°C. In these conditions, the battery cannot be charged due to safety limits with lithium-ion battery technology.

Check to ensure that the USB cable and the AC wall charger are connected securely and are working correctly.

If the device is left charging for over seven consecutive days, the device automatically enters a battery longevity mode to enhance the life of the battery. During this state, the device stops charging and allows the battery level to drop to and maintain at approximately 75 percent. The next time the device is plugged into a charger, it resumes charging.

Why is the Signal Strength indicator always low?

Your mobile hotspot's reception is poor. Try moving it to a location with a clear view of the sky (for example, near a window).

Why is the download or upload speed slow?

Data transfer speed depends on signal strength and interfering radio sources like electrical generators or other mobile hotspot Wi-Fi devices. Review the following possibilities:

- Check your signal strength and network type (for example, LTE 4G is generally faster than 3G).
- Check Wi-Fi interference by powering the mobile hotspot off and on to find a better Wi-Fi channel.
- Change the Wi-Fi band from 2.4 GHz to 5 GHz.
- If the network signal is low, consider using external antennas or cradle the mobile hotspot with built-in high-gain antennas.

The LCD screen is not lit. How do I know if the mobile hotspot is still powered on?

The LCD screen dims to save energy. The LED continues to blink slowly to indicate that the mobile hotspot is still powered on. To wake the mobile hotspot, press and quickly release the **Power** button.

How do I find my computer's IP address?

The steps for finding your computer's IP address depend on the operating system. If your device runs an operating system not listed here, see the appropriate operating system documentation.

Find the IP address on a Windows 7 , Windows Vista , or Windows XP device To find the IP address on a Windows 7 , Windows Vista , or Windows XP device:

1. Open the command prompt window:
 - a. Select **Start > Run**.
 - b. Enter **cmd** or **command** and click the **OK** button.
2. At the command prompt, enter **ipconfig** and press **Enter**.
3. Write down the IP address for the entry that relates to the Wi-Fi network connection. The IP address might be listed under IPv4 Address or something similar.

Find the IP address on a Windows 8 device To find the IP address on a Windows 8 device:

1. In the Charms bar, click the **Search** button.
2. Select **Command Prompt**.
3. At the command prompt, enter **ipconfig** and press **Enter**.
4. Write down the IP address for the entry that relates to the Wi-Fi network connection. The IP address might be listed under IPv4 Address or something similar.

Find the IP address on a Mac OS X device To find the IP address on a Mac OS X device:

1. From the Apple menu, select **System Preferences > Network**.
2. Select the Wi-Fi adapter.

The IP address is displayed in the right pane.

Find the IP address on devices running other operating systems To find the IP address on devices running other operating systems:

Refer to the user documentation for your operating system or computer.

How do I find a device's MAC address?

You must know the MAC address for a device when you are doing the following:

- Assigning an IP address based on a MAC address (when using DHCP)
- Allowing or denying devices access to your Wi-Fi network (MAC filtering)

Tip: To display a list of connected devices, including the MAC address of each device, go to the mobile hotspot web page and log in as an administrator. The connected devices list appears on the left side of the home page. Click the device links to display IP and MAC addresses.

The steps for finding a device's MAC address depend on the operating system. If your device runs an operating system not listed in the following procedures, see the appropriate operating system documentation.

Find the MAC address on a Windows 7, Vista , or XP device To find the MAC address on a Windows 7, Vista , or XP device:

1. Open the command prompt window:
 - a. Select **Start > Run**.
 - b. Enter **cmd** or **command** and click the **OK** button.
2. At the command prompt, enter **ipconfig /all** and press **Enter**.
3. Write down the physical address for the entry that relates to the Wi-Fi network connection.

It appears as a series of numbers and letters. This is the MAC address of your Wi-Fi adapter.

Find the MAC address on a Windows 8 device or newer To find the MAC address on a Windows 8 device or newer:

1. In the **Charms** bar, click the **Search** button.
2. Select **Command Prompt**.
3. At the command prompt, enter **ipconfig /all** and press the **Enter** button.
4. Write down the physical address for the entry that relates to the Wi-Fi network connection.

It appears as a series of numbers and letters. This is the MAC address of your wireless adapter.

Find the MAC address on a Mac OS X device To find the MAC address on a Mac OS X device:

1. From the Apple menu, select **System Preferences > Network**.
2. Select the Wi-Fi adapter that is connecting to the routing hardware.
3. Select **Advanced**.
4. Select **Ethernet**.

The Ethernet ID is displayed. This is the same as the MAC address.

What do I do if the Wi-Fi network name doesn't appear in the list of networks?

If you do not see the mobile hotspot's Wi-Fi networks from your Wi-Fi-enabled device, try these suggestions:

- Refresh the list of networks.
- If the LCD screen is dark, the Wi-Fi radio might be asleep. Press the **Power** button to wake the mobile hotspot.
- Check the Wi-Fi band settings and consider using the 2.4 GHz band for increased compatibility with client devices.

6

Troubleshooting

This chapter provides suggestions for troubleshooting problems that might arise when you are using your mobile hotspot. The chapter covers the following topics:

- [View Alerts](#)
- [Reset the Mobile Hotspot](#)

View Alerts

Your mobile hotspot displays alerts to advise you of device status changes. See [View Messages From the Mobile Hotspot Web Page](#) on page 20.

SIM Not Installed

Ensure that the micro SIM card is installed correctly. The mobile hotspot comes with a preinstalled SIM. For information about replacing a SIM, see [Replace a SIM Card](#) on page 11.

SIM Error – Check SIM

Ensure that your network service provider's micro SIM card is inserted in the mobile hotspot. If a problem still exists, contact customer service. The micro SIM card might be damaged and need replacing.

SIM Locked

You can unlock the SIM.

To unlock the micro SIM card from the mobile hotspot web page:

1. Contact customer service for the PIN to unlock the micro SIM card.
2. From a computer or Wi-Fi device that is connected to the mobile hotspot, launch a web browser.
3. Enter **http://192.168.1.1** or **http://cricketwifi/**.
The mobile hotspot web page displays.
4. Enter the administrator login password.
The default password is **cktadmin**. The password is case-sensitive.
The home page displays.
5. Enter the micro SIM PIN when prompted.
6. Click the **Save** button.
Your settings are saved.

Temperature-Related Alerts

The mobile hotspot is designed to work over a wide temperature range. (For more information, see [Environmental Specifications](#) on page 84.) The mobile hotspot shuts down automatically if it goes out of the supported temperature range.

Move the device to an area where the temperature is more suitable and, if the mobile hotspot is too warm, make sure that the area is well ventilated and air can circulate around the device.

Note: The battery might not recharge if the mobile hotspot is outside the operating temperature range.

Connection Alerts

Some connection alerts include instructions for resolving them. For other connection alerts, including those in the following table, contact customer service for assistance.

Table 2. Connection alerts

Alert	Description
8	Operator determined barring
25	LLC or SMDCP failure
26	Insufficient resources
27	Missing or unknown APN
28	Unknown PDP address or type
29	User authentication failed
30	Activation rejected by GGSN
32	Service Option not supported
33	Service Option not subscribed
34	Service Option temporarily out of order
36	Regular deactivation
37	QoS not accepted
38	Network failure
39	Reactivation required
40	Feature not supported

Table 2. Connection alerts (Continued)

41	Semantic error in the TFT operation
42	Syntactical error in the TFT operation
43	Unknown PDP context
44	PDP context without TFT already activated
45	Semantic errors in packet filters
46	Syntactical errors in packet filters
67	Connection error
81	Invalid transaction identifier value
95	Semantically incorrect message
96	Invalid mandatory information
97	Message type nonexistent or not implemented
98	Message type not compatible with the protocol state
99	Information element non-existent or not implemented
100	Conditional IE error
101	Message not compatible with the protocol state
111	Protocol error, unspecified
256	Invalid Connection ID
258	Invalid PRI NSAPI
259	Invalid Field
260	SNDCP Failure
261	RAB Setup Failure
262	No GPRS Context
263	PDP Establish Max Timeout
264	PDP Activate Max Timeout
265	PDP Modify Max Timeout
266	PDP Inactivate Max Timeout
267	PDP Lower layer Error

Table 2. Connection alerts (Continued)

268 PDP Duplicate

269 UE RAT Change

Reset the Mobile Hotspot

You can reset the mobile hotspot to the factory settings. This is useful if you forgot your admin login password for the mobile hotspot web page.

If you reset the mobile hotspot, all of your customizations are lost. If you want to keep them, save them before doing the reset and restore them afterward. See [Back Up and Restore Mobile Hotspot Settings](#) on page 54.

Note: When you reset the mobile hotspot, any currently connected devices lose access and must be reconnected after the mobile hotspot restarts.

Reset the Mobile Hotspot From the Mobile Hotspot

Start with the mobile hotspot turned on.

To reset the mobile hotspot directly from the mobile hotspot:

1. Press and hold the **power** button for at least 15 seconds.
The mobile hotspot enters factory reset mode and first displays the message, "Shutting down," followed by the message "Continue holding Power button to reset all settings to factory default," and then "Resetting Device. Please do not power off."

Note: If you release the **power** button too soon, the mobile hotspot turns off instead of resetting.

Reset the Mobile Hotspot From the Mobile Hotspot Web Page

To reset the mobile hotspot to its factory settings:

1. From a computer or Wi-Fi device that is connected to the mobile hotspot, launch a web browser.
 2. Enter **http://192.168.1.1** or **http://cricketwifi/**.
The mobile hotspot web page displays.
 3. Enter the administrator login password.
-

The default password is **cktadmin**. The password is case-sensitive.
The home page displays.

4. Select **Settings > General > Software and Reset**.

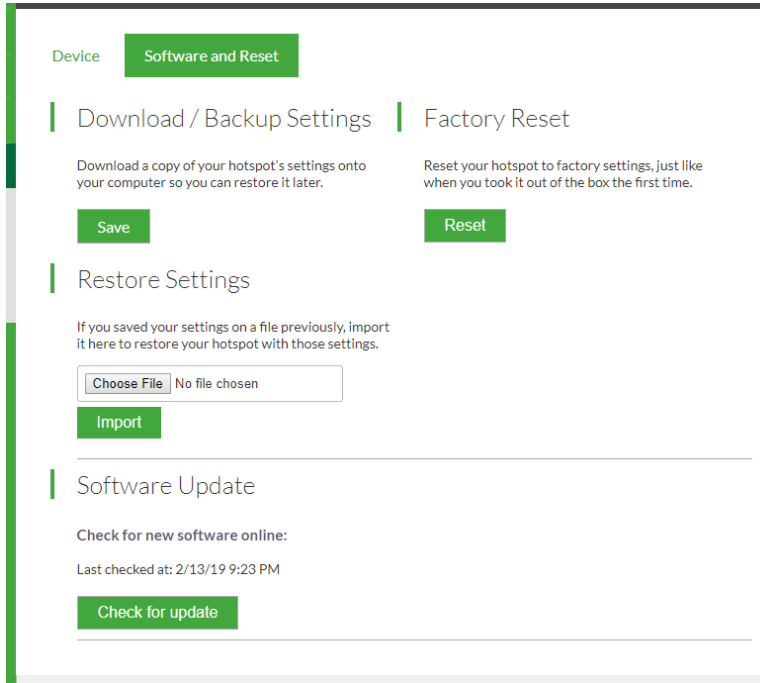

5. Click the **Reset** button.
A message displays telling you that devices currently connected will lose Internet access.
6. Click the **OK** button.
The mobile hotspot returns to its factory settings.

A

Specifications

This appendix covers the following topics:

- [Battery Specifications](#)
- [Display Specifications](#)
- [Environmental Specifications](#)
- [Mechanical Specifications](#)
- [Mobile Band Specifications](#)
- [Package Contents](#)
- [Port Specifications](#)
- [Security Specifications](#)
- [WiFi Specifications](#)

Battery Specifications

Battery specifications:

- Removable Li-ion battery
- Up to approximately 11 hours of battery life achieved by the following use case: stream YouTube for 1 hour, followed by 30 minutes of idle time, and then repeat for 11 hours. Actual battery life will vary depending on network and environmental conditions, devices connected, device settings, content streamed, and battery age.

Display Specifications

The mobile router includes an 1.77 in. LCD display.

Environmental Specifications

Table 3. Recommended operating and storage temperatures

Environment	Temperature
Operating temperature	0°C to 35°C (32 F to 95°F)
Storage temperature	-10°C to +60°C (14°F to 140°F)

Mechanical Specifications

Table 4. Physical dimensions

Parameter	Dimension
Weight	78 g (2.75 oz) without battery, 136 g (4.80 oz) with battery
Length	110 mm (4.33 in.)
Width	68 mm (2.68 in.)
Thickness	15.4 mm (0.61 in.)

Mobile Band Specifications

Table 5. Mobile Bands

Technology	Band
4G/LTE bands	1, 2, 3, 4, 5, 7, 12, 14, 29, 30, 66
3G fallback support (DC-HSPA+)	850, 1900, 2100

Package Contents

Your mobile router package includes the following:

- AirCard 797S Mobile Hotspot
- Pre-installed SIM card
- Removable lithium ion battery
- AC charger
- USB cable
- Quick Start Guide

Port Specifications

The mobile router provides one micro-USB 2.0 port.

Security Specifications

Supported security features:

- Content filtering/Parental controls
- Guest WiFi with optional timer
- WiFi security encryption
- WiFi Protected Setup (WPS)
- VPN pass-through
- NAT firewall
- Password protected administration UI

WiFi Specifications

WiFi support:

- WiFi 802.11ac, 2x2 MIMO
- Dual-Band 2.4/5 GHz, standalone or simultaneous
- Multiple SSID/Guest WiFi Support with optional timer
- WPS (WiFi Protected Setup)